

Hemidesmosome Formation Is Initiated by the $\beta 4$ Integrin Subunit, Requires Complex Formation of $\beta 4$ and HD1/Plectin, and Involves a Direct Interaction between $\beta 4$ and the Bullous Pemphigoid Antigen 180

Roel Q.J. Schaapveld,* Luca Borradori,** Dirk Geerts,* Manuel R. van Leusden,* Ingrid Kuikman,* Mirjam G. Nievers,* Carien M. Niessen,* Renske D.M. Steenbergen,§ Peter J.F. Snijders,§ and Arnoud Sonnenberg*

*Division of Cell Biology, The Netherlands Cancer Institute, 1066 CX Amsterdam, The Netherlands; †Department of Dermatology, University of Geneva, CH-1211 Geneva, Switzerland; and §Department of Pathology, University Hospital Vrije Universiteit, 1081 HV Amsterdam, The Netherlands

Abstract. Hemidesmosomes (HDs) are stable anchoring structures that mediate the link between the intermediate filament cytoskeleton and the cell substratum. We investigated the contribution of various segments of the $\beta 4$ integrin cytoplasmic domain in the formation of HDs in transient transfection studies using immortalized keratinocytes derived from an epidermolysis bullosa patient deficient in $\beta 4$ expression. We found that the expression of wild-type $\beta 4$ restored the ability of the $\beta 4$ -deficient cells to form HDs and that distinct domains in the NH₂- and COOH-terminal regions of the $\beta 4$ cytoplasmic domain are required for the localization of HD1/plectin and the bullous pemphigoid antigens 180 (BP180) and 230 (BP230) in these HDs. The tyrosine activation motif located in the connecting segment (CS) of the $\beta 4$ cytoplasmic domain was dispensable for HD formation, although it may be involved in the efficient localization of BP180. Using the yeast two-hybrid system, we could demonstrate a direct interaction between $\beta 4$ and BP180 which involves sequences within the COOH-terminal part of the CS and

the third fibronectin type III (FNIII) repeat. Immunoprecipitation studies using COS-7 cells transfected with cDNAs for $\alpha 6$ and $\beta 4$ and a mutant BP180 which lacks the collagenous extracellular domain confirmed the interaction of $\beta 4$ with BP180. Nevertheless, $\beta 4$ mutants which contained the BP180-binding region, but lacked sequences required for the localization of HD1/plectin, failed to localize BP180 in HDs. Additional yeast two-hybrid assays indicated that the 85 COOH-terminal residues of $\beta 4$ can interact with the first NH₂-terminal pair of FNIII repeats and the CS, suggesting that the cytoplasmic domain of $\beta 4$ is folded back upon itself. Unfolding of the cytoplasmic domain may be part of a mechanism by which the interaction of $\beta 4$ with other hemidesmosomal components, e.g., BP180, is regulated.

Key words: hemidesmosome assembly • PA-JEB keratinocytes • protein-protein interaction • bullous pemphigoid antigens • $\alpha 6\beta 4$ integrin

HEMIDESMOSOMES (HDs)¹ are specialized multiprotein complexes that mediate the adhesion of basal epithelial cells to the basement membrane in stratified and certain complex epithelia, and provide a link

R.Q.J. Schaapveld, Luca Borradori, and D. Geerts contributed equally to this work.

Address all correspondence to A. Sonnenberg, Division of Cell Biology, The Netherlands Cancer Institute, Plesmanlaan 121, 1066 CX Amsterdam, The Netherlands. Tel.: (31) 20-5121942. Fax: (21) 20-5121944. E-mail: asonn@nki.nl

Carlen M. Niessen's present address is Cellular Biochemistry & Biophysics Program, Memorial Sloan-Kettering Cancer Center, 1275 York Avenue, New York 10021.

1. *Abbreviations used in this paper:* AD, activation domain; BD, binding domain; BP180, bullous pemphigoid antigen 180; BP230, bullous pem-

phigoid antigen 230; CS, connecting segment; FNIII, type III fibronectin repeat; GAL4, galactose metabolism regulatory gene 4; HDs, hemidesmosomes; IF, intermediate filament; NHK, normal human foreskin keratinocytes; PA-JEB, junctional epidermolysis bullosa associated with pyloric atresia; SC, synthetic complete medium; TAM, tyrosine activation motif.

phigoid antigen 230; CS, connecting segment; FNIII, type III fibronectin repeat; GAL4, galactose metabolism regulatory gene 4; HDs, hemidesmosomes; IF, intermediate filament; NHK, normal human foreskin keratinocytes; PA-JEB, junctional epidermolysis bullosa associated with pyloric atresia; SC, synthetic complete medium; TAM, tyrosine activation motif.

genes for the $\beta 4$ or the $\alpha 6$ integrin subunits cause junctional epidermolysis bullosa associated with pyloric atresia (PA-JEB), an inherited skin blistering disorder characterized by defective dermo-epidermal adhesion and the formation of only rudimentary HDs (Vidal et al., 1995; Brown et al., 1996; Niessen et al., 1996; Pulkkinen et al., 1997; Ruzzi et al., 1997). Similarly, targeted disruption of the genes for $\alpha 6$ or $\beta 4$ results in widespread subepidermal blistering in neonatal mice, which are unable to form HDs (Dowling et al., 1996; Georges-Labouesse et al., 1996; Van der Neut et al., 1996).

$\alpha 6\beta 4$ is a receptor for various laminin isoforms, including laminin-5 (Niessen et al., 1994; Rousselle and Aumailley, 1994), a major component of the epidermal basement membrane (Carter et al., 1991; Rousselle et al., 1991). $\alpha 6\beta 4$ -mediated adhesion and signaling are likely to be regulated by the cytoplasmic domain of $\beta 4$ (Spinardi et al., 1993, 1995; Giancotti, 1996). This domain consists of $\sim 1,000$ amino acid residues and contains two pairs of type III fibronectin (FNIII) repeats which are separated by a connecting segment (CS) (Hogervorst et al., 1990; Suzuki and Naitoh, 1990; Tamura et al., 1990). Recent studies have identified sequences within the second FNIII repeat and the CS that appear to be critical for the localization of $\alpha 6\beta 4$ in HDs (Spinardi et al., 1993; Mainiero et al., 1995; Niessen et al., 1997a). Furthermore, the $\beta 4$ cytoplasmic domain appears to form a complex with the hemidesmosomal plaque component HD1/plectin and to regulate the subcellular localization of HD1/plectin (Niessen et al., 1997b) and of the bullous pemphigoid antigen 180 (BP180) (Borradori et al., 1997). BP180, a collagenous protein, is the other known transmembrane hemidesmosomal constituent that is also likely to function as a cell-matrix receptor (Giudice et al., 1992; Li et al., 1993; Jonkman et al., 1995; McGrath et al., 1995). BP180 has been suggested to interact with the $\alpha 6$ integrin subunit, and this interaction may contribute to the stabilization of HDs (Hopkinson et al., 1995).

The cytoplasmic hemidesmosomal proteins include, in addition to HD1/plectin (Wiche et al., 1991; Hieda et al., 1992), the bullous pemphigoid antigen 230 (BP230) (Stanley et al., 1988; Sawamura et al., 1991), IFAP300 (Yang et al., 1985; Skalli et al., 1994), and the P200 protein (Kurpakus and Jones, 1991). IFAP300 and HD1/plectin appear to be related and may even be identical (Herrmann and Wiche, 1987; Baker et al., 1997). HD1/plectin and BP230 mediate the attachment of keratin IFs to the basal plasma membrane, since in patients with epidermolysis bullosa simplex with muscular dystrophy, who lack HD1/plectin, and in null mutant mice lacking either HD1/plectin or BP230 the attachment of IFs to HDs is strongly reduced (Guo et al., 1995; Gache et al., 1996; McLean et al., 1996; Smith et al., 1996; Andr a et al., 1997).

Recent cell transfection studies have defined regions in the $\beta 4$ cytoplasmic domain that are important for the localization of $\alpha 6\beta 4$ within HDs, based on the ability of $\beta 4$ mutants to become incorporated into HDs or to disrupt them (Spinardi et al., 1993; Mainiero et al., 1995; Niessen et al., 1997a). However, the value of these studies is limited because the cells used express $\beta 4$ endogenously and form HDs, so that mutants could associate with preexisting HDs. Thus, it was not demonstrated whether the mu-

tants are able to initiate HD formation. The availability of human $\beta 4$ -deficient keratinocytes thus provides a unique opportunity to investigate the role $\beta 4$ and of specific domains in $\beta 4$ in the formation of HDs and the recruitment of other hemidesmosomal components.

In this study, we have used immortalized keratinocytes derived from a patient with PA-JEB, who completely lacked expression of the $\beta 4$ integrin subunit (Niessen et al., 1996). We report experiments aimed at defining: (a) the ability of these immortalized PA-JEB keratinocytes to assemble HD-like structures; (b) the feasibility to reverse their phenotype by reexpressing wild-type $\beta 4$; (c) the potential of $\beta 4$ mutants, lacking distinct regions of the $\beta 4$ cytoplasmic domain or carrying mutations in the tyrosine activation motif (TAM), to induce the formation of HD-like structures by recruiting the hemidesmosomal components HD1/plectin, BP180, and BP230 to sites of cell-substrate contact; and (d) the interaction between the cytoplasmic domain of $\beta 4$ and BP180.

Materials and Methods

Generation of Immortalized Cell Lines

HPV 16 immortalized normal human foreskin keratinocytes (NHK) have been described previously (Steenbergen et al., 1996). NHK morphologically resemble the parental cells, but they are slightly larger and flatter (Steenbergen et al., 1996). Also, the cells are less stratified even when they reach confluence.

Primary keratinocytes obtained from a patient with PA-JEB who completely lacked expression of the $\beta 4$ integrin subunit (Niessen et al., 1996) were immortalized by transfection with full-length HPV 16 DNA (p1432; M nger et al., 1989). This resulted in the generation of a clonal culture that was expanded for further characterization. The cells were relatively large with a polygonal shape and morphologically resembled the parental cells. They grew with a doubling time of ~ 36 h and showed normal stratification and differentiation as detected by electron microscopy upon culture postconfluent in HAMF12/DME (1:3) medium (data not shown). Ultrastructural analysis of the PA-JEB keratinocytes showed that in the absence of $\beta 4$ only a few rudimentary HD-like structures are formed in some cells, as in PA-JEB patients (Vidal et al., 1995; Niessen et al., 1996; data not shown).

Cells and Antibodies

The two keratinocyte cell lines were grown in keratinocyte serum-free medium (SFM) (GIBCO-BRL, Paisley, UK) supplemented with 50 $\mu\text{g}/\text{ml}$ bovine pituitary extract, 5 ng/ml epidermal growth factor, 100 U/ml penicillin, and 100 U/ml streptomycin. Alternatively, the cells were cultured in HAMF12/DME (1:3) medium containing 10% (vol/vol) FCS, 100 U/ml penicillin, 100 U/ml streptomycin, L-glutamine, 0.4 $\mu\text{g}/\text{ml}$ hydrocortisone (Sigma Chemical Co., St. Louis, MO) and 1 μM isoproterenol (Sigma Chemical Co.). The African monkey kidney cell line COS-7 was cultured in DME (GIBCO-BRL) supplemented with 10% (vol/vol) FCS, 100 U/ml penicillin, and 100 U/ml streptomycin. The cells were grown at 37°C in a humidified, 5% CO_2 atmosphere.

The following antibodies against human integrin subunits were used: the mouse mAbs P1E6 and P1H5, anti- $\alpha 2$ (Wayner and Carter, 1987); the mAb J143, anti- $\alpha 3$ (Kantor et al., 1987); the mAb Sam-1, anti- $\alpha 5$ (Keizer et al., 1987) and the NKI-M9, anti- αv (Von dem Borne et al., 1989) were obtained from C.G. Figdor (University of Nijmegen, Nijmegen, The Netherlands); the mouse mAb J8H, the rat mAb GoH3 and a rabbit polyclonal antiserum, anti- $\alpha 6$ have been described (Sonnenberg et al., 1987; Hogervorst et al., 1993; Delwel et al., 1994); the mouse mAb 113C, anti- $\beta 4$, was prepared by A.M. Mart nez de Velasco in our laboratory (unpublished results); the mouse mAb 4.3E1 against $\beta 4$ (Hessle et al., 1984) was provided by E. Engvall (The Burnham Institute, La Jolla, CA); the mouse mAbs 450-10D and 450-9D, and the rat mAb 439-9B, anti- $\beta 4$ (Kennel et al., 1989, 1990), were kindly provided by S.J. Kennel (Oak Ridge National

Laboratory, Oak Ridge, TN); a rabbit antiserum (67p120) to recombinant human $\beta 4$ cytoplasmic domain was prepared as previously described (Niessen et al., 1994); the rat mAb A11B2, anti- $\beta 1$ (Werb et al., 1989), was a gift from C.H. Damsky (University of California, San Francisco, CA); an the mAb TS2/16 against $\beta 1$ was obtained from the American Type Culture Collection (Rockville, MD). A rabbit antiserum to rat IgG has been described previously (Sonnenberg et al., 1986). The mouse mAb V11F9 against vinculin (Glukhova et al., 1990) was a generous gift from M.A. Glukhova (École Normale Supérieure, Paris, France). A rabbit antiserum directed against the COOH-terminal domain of BP230 (Tanaka et al., 1990) was kindly provided by J.R. Stanley (University of Pennsylvania, Philadelphia, PA). The mouse mAbs 1D1 and 233 against the intra- and extracellular portion of BP180, respectively (Nishizawa et al., 1993), and the mAb 121 directed against HD1 (Hieda et al., 1992) were kindly donated by K. Owaribe (Nagoya University, Nagoya, Japan). A rabbit antiserum against the cytoplasmic domain of BP180 was generously provided by L. Bruckner-Tuderman (University of Münster, Münster, Germany). The mouse mAb anti-FLAG™ M2 against the FLAG™ peptide (DYKDDDDK) was purchased (IBI, Eastman Kodak Co., New Haven, CT). Species-specific FITC-conjugated goat anti-mouse IgG (Zymed Laboratories, San Francisco, CA), Texas red-conjugated goat anti-rat IgG (Rockland, Gilbertsville, PA), and Texas red-conjugated donkey anti-rabbit IgG (Amersham Int., Buckinghamshire, UK) were purchased, as were species-specific horseradish peroxidase-conjugated antibodies (Amersham Int.).

cDNA Constructs

The full-length $\beta 4A$ and $\beta 4B$ cDNA constructs, and the cDNA constructs encoding $\beta 4$ with COOH-terminal truncations or internal deletions of the cytoplasmic domain have been described previously (Niessen et al., 1997a,b). The cDNA plasmid encoding $\beta 4A$ with combined phenylalanine substitutions of the tyrosine activation motif (Mainiero et al., 1995) was kindly provided by F.G. Giancotti (New York University School of Medicine, New York). The construct was assembled into pcDNA3 (Stratagene, La Jolla, CA). The pRc-CMV expression construct encoding full-length $\alpha 6A$ cDNA, as well as the pCI-Neo construct encoding the cytoplasmic domain of BP180 (clone B, BP180^{Δ521-1497}) have been described previously (Borradori et al., 1997). Correctness of all constructs was verified by sequencing. The molecular weights of the different expressed $\beta 4$ proteins correspond to that predicted based on the DNA sequences, as assessed by Western blot analysis of transiently transfected COS-7 cells (Niessen et al., 1997a; data not shown).

DNA Transfections

For transfection, the keratinocytes were first grown in keratinocyte-SFM medium to 40–60% confluency in six-well tissue culture plates (Falcon; Becton Dickinson, Lincoln Park, NJ). The cells were transfected using the cationic lipid Lipofectin® (GIBCO-BRL). The DNA/Lipofectin® mixture was prepared using serum-free medium (OPTI-MEM®, GIBCO-BRL). The final concentration of plasmid DNA and Lipofectin® in serum-free transfection medium was 2.5 $\mu\text{g}/\text{ml}$ and 10 $\mu\text{g}/\text{ml}$, respectively. 1 ml of transfection medium was added to each monolayer that had been previously washed with serum-free medium and cells were incubated with the transfection medium for 9–10 h at 37°C with 5% CO₂. The transfection medium was then replaced with keratinocyte-SFM medium for 12 h and subsequently with HAMF12/DME (1:3) medium for an additional 24 h, after which gene expression was assessed.

COS-7 cells (1.2×10^6 cells/60 cm²) were transiently transfected using the DEAE-dextran method (Cullen, 1987) with 2 μg of DNA per construct and assayed for gene expression after 48 h.

Immunofluorescence Microscopy

Cells grown on glass coverslips in six-well tissue culture plates in HAMF12/DME (1:3) medium for 24 h were fixed with 1% formaldehyde in PBS for 10 min and permeabilized with 0.5% Triton X-100 for 5 min at room temperature. After rinsing with PBS and blocking with 2% (wt/vol) BSA in PBS for 30 min at 37°C, the cells were incubated with primary antibody for 30 min at 37°C and then washed three times with PBS. The cells were subsequently incubated with FITC-labeled anti-mouse IgG, Texas red-labeled anti-rabbit IgG, Texas red-labeled anti-rat IgG, or rabbit anti-rat IgG followed by Texas red-labeled donkey anti-rabbit IgG for 30 min

at 37°C, respectively. For double labeling studies, cells were incubated with the respective antibodies as described previously (Niessen et al., 1997a). The coverslips were subsequently washed, mounted in Vectashield (Vector Labs, Inc., Burlingame, CA), and then viewed under a Bio-Rad MRC-600 confocal scanning laser microscope (Richmond, CA).

Immunoprecipitation Studies and Immunoblotting

Keratinocytes cultured in keratinocyte-SFM medium were detached using 20 mM EDTA in PBS and washed three times with PBS. Cells were surface-labeled with ¹²⁵I (Amersham Int.) by the lactoperoxidase/hydrogen peroxide method (Sonnenberg et al., 1987; Niessen et al., 1996). Thereafter, the cells were washed three times with PBS and lysed on ice with NP-40 lysis buffer (1% Nonidet P-40, 25mM Tris-HCl, pH 7.5, 4 mM EDTA, 100 mM NaCl, 1 mM PMSF, 10 $\mu\text{g}/\text{ml}$ leupeptin, and 10 $\mu\text{g}/\text{ml}$ soybean trypsin inhibitor). The lysates were then used for immunoprecipitation, as described previously (Sonnenberg et al., 1993; Niessen et al., 1996). Immune complexes were released from the beads by boiling for 5 min in non-reducing SDS sample buffer and resolved on a 5% SDS-PAGE gel.

Alternatively, keratinocytes were washed twice with PBS and incubated with DME without methionine and cysteine (ICN Biomedicals Inc., Costa Mesa, CA) for 1 h at 37°C. Cells were then labeled with 100 $\mu\text{Ci}/\text{ml}$ [³⁵S]methionine/cysteine (Amersham Int.) for 4 h, washed, and then lysed with NP-40 lysis buffer and used for immunoprecipitation analysis as described above.

Transfected COS-7 cells were washed twice with PBS and scraped in 1 ml CHAPS lysis buffer (1% CHAPS, 25 mM Hepes, pH 7.5, 150 mM NaCl, 5 mM MgCl₂, 1 mM PMSF, 10 $\mu\text{g}/\text{ml}$ leupeptin and 10 $\mu\text{g}/\text{ml}$ soybean trypsin inhibitor). The lysates were clarified by centrifugation and incubated with antibodies previously bound to GammaBind plus Sepharose CL4B beads (Pharmacia LKB Biotech., Uppsala, Sweden). Immune complexes were washed three times with lysis buffer and two times with PBS. Immunoprecipitates were released from the beads by boiling for 5 min in non-reducing SDS sample buffer, resolved on an 8% SDS-PAGE gel, and blotted to polyvinylidene difluoride membranes (Immobilon-P; Millipore Corp., Waters Chromatography, Bedford, MA). The immunoblots were blocked for 1 h in TBSTB (10 mM Tris, pH 8.0, 150 mM NaCl, 0.05% Tween-20, 2% [wt/vol] baby milk powder) and probed with primary antibodies in TBSTB for 1 h at room temperature. After extensive washing in TBSTB (with only 0.2% [wt/vol] baby milk powder), blots were incubated for 1 h with secondary horseradish peroxidase-conjugated antibodies diluted 1:5,000 in TBSTB. The blots were then washed again and developed using enhanced chemiluminescence (Amersham Int.).

Yeast Two-hybrid Assay

All yeast galactose metabolism regulatory gene 4 (GAL4) expression plasmids containing parts of the $\beta 4$ or BP180 cytoplasmic domains that were used for the yeast two-hybrid assay are listed in Figs. 10 and 12. Numbers in superscript correspond to the $\beta 4$ amino acid residues (numbered according to Niessen et al., 1997a) that are encoded within the GAL4 activation domain (AD) or binding domain (BD) fusion proteins. The sequences encoding $\beta 4$ were amplified by PCR from the full-length $\beta 4A$ and $\beta 4B$ cDNA constructs used for the transfection studies described above, using $\beta 4$ -specific sense and antisense primers containing restriction site tags. PCR products were cut with the appropriate restriction enzymes, correctly sized DNA fragments were isolated from agarose gels using the Easy-Pure™ kit (Biozym, Landgraaf, The Netherlands), and ligated into the yeast GAL4(AD) expression vector pACT2 (Harper, 1993; Clontech, Palo Alto, CA) cut with conforming restriction enzymes. This resulted in the in-frame fusion of each $\beta 4$ coding sequence to the 3' end of the GAL4 (768–881) transcriptional AD. For the experiments described in Fig. 12, several $\beta 4$ sequences were recloned into the yeast GAL4 (BD) expression vector pAS2-1 (Durfee et al., 1993; Clontech) using restriction sites in the polylinkers of the vectors. This resulted in the in-frame fusion of $\beta 4$ -encoding sequences to the 3' end of the GAL4 (1–147) DNA-BD.

A cDNA clone containing nucleotides 1–1,398 encoding the entire cytoplasmic domain, i.e., the first 466 amino acid residues, of human BP180 (Hopkinson et al., 1992) was isolated from a λ gt11 human keratinocyte library by PCR using BP180-specific sense and antisense primers containing restriction site tags, purified and cut with the appropriate restriction enzymes as described above, and then cloned into pAS2-1. This BP180 construct, pAS2-BP180(0), caused autonomous activation of the reporter genes in the yeast host strain, presumably because of the presence of multiple Gly and Cys residues in the BP180 protein sequence immediately pre-

ceding the putative transmembrane region. A subclone containing only the first 1,201 nucleotides of the BP180 sequence and lacking the nucleotides encoding the Gly and Cys repeats was isolated from pAS2-BP180(0) using the *Stu*I site (at position 1,201 in the BP180 sequence) and recloned into pAS2-1, resulting in pAS2-BP180(C) which encodes the first 400 amino acids of the BP180 protein. This construct did not cause autonomous transactivation of the reporter genes in the yeast host strain. The BP180 and β 4 coding sequences within the yeast expression constructs were confirmed by sequence analysis using the 32 P-Sequencing kit (Pharmacia Biotech).

Yeast strain PJ69-4A (gift of P. James, University of Wisconsin, Madison, WI), which contains the genetic markers *trp1-901*, *leu2-3*, *his3-200*, *gal4 Δ* , *gal80 Δ* , *LYS2::GAL1-HIS3*, and *GAL2-ADE2* (James et al., 1996), was used as the host strain for the two-hybrid assay. It contains two tightly regulated and selectable *GAL4*-driven reporter genes, *His* and *Ade*, and is therefore suited for sensitive detection of protein interactions. Strain PJ69-4A was grown and transformed with plasmid DNA essentially as described (Gietz et al., 1995; James et al., 1996). PJ69-4A yeast cells were cotransformed with a pACT2 (-derived) plasmid as well as a pAS2-1 (-derived) plasmid, and aliquots of the same transformation were spread on plates containing SC-LT medium, yeast synthetic complete medium (SC) lacking only the vector markers *Leu* (for pACT2 and derivatives) and *Trp* (for pAS2-1 and derivatives), and on plates containing SC-LTHA medium, lacking *Leu* and *Trp* as well as the interaction markers *His* and *Ade*. Plates were scored after 4 and 9 d of growth, and the number of colonies on the SC-LT plate compared with that on the SC-LTHA plate. As a positive control for *GAL4*-driven activation of the *Ade* and *His* reporter genes of PJ69-4A, two combinations of vectors were used that enable growth on SC-LTHA plates. One combination was pCL1, full-length *GAL4* (which is able to activate the two reporter genes on its own) in a pACT2-like vector (Fields and Song, 1989; Clontech) together with the empty pAS2-1 vector. In the other combination, two vectors, pTD1-1, SV-40 large T antigen in pACT2 (Li and Fields, 1993; Clontech), together with

pVA3-1, a p53 subclone in pAS2-1 (Iwabuchi et al., 1993; Clontech), were used, that express proteins that are known to interact and thereby cause expression of the reporter genes.

Results

Altered Distribution of Hemidesmosomal Components in Immortalized PA-JEB Keratinocytes

We investigated the distribution of hemidesmosomal proteins in preconfluent monolayers of the immortalized NHK and PA-JEB cell lines by confocal immunofluorescence microscopy. In NHK, the α 6 β 4 integrin and HD1/plectin were concentrated at cell-substrate contact sites in structures appearing as dots and large patches (Fig. 1, A, B, and E). This staining pattern is characteristic for HD-like structures (Marchisio et al., 1991, 1993) or stable anchoring contacts (Carter et al., 1990) of cultured keratinocytes. In addition, the localization pattern of BP230 and BP180 was similar to that of α 6 β 4 and HD1/plectin, although the staining was less extensive in most cells (Fig. 1, C and D). In the PA-JEB cells, no β 4 staining was found using mAbs directed against either the extra- or the intracellular domain of β 4 (Fig. 1 G; data not shown). α 6 (Fig. 1 F) was codistributed with vinculin in short linear arrays at the basal cell surface at the ends of actin stress fibers (data

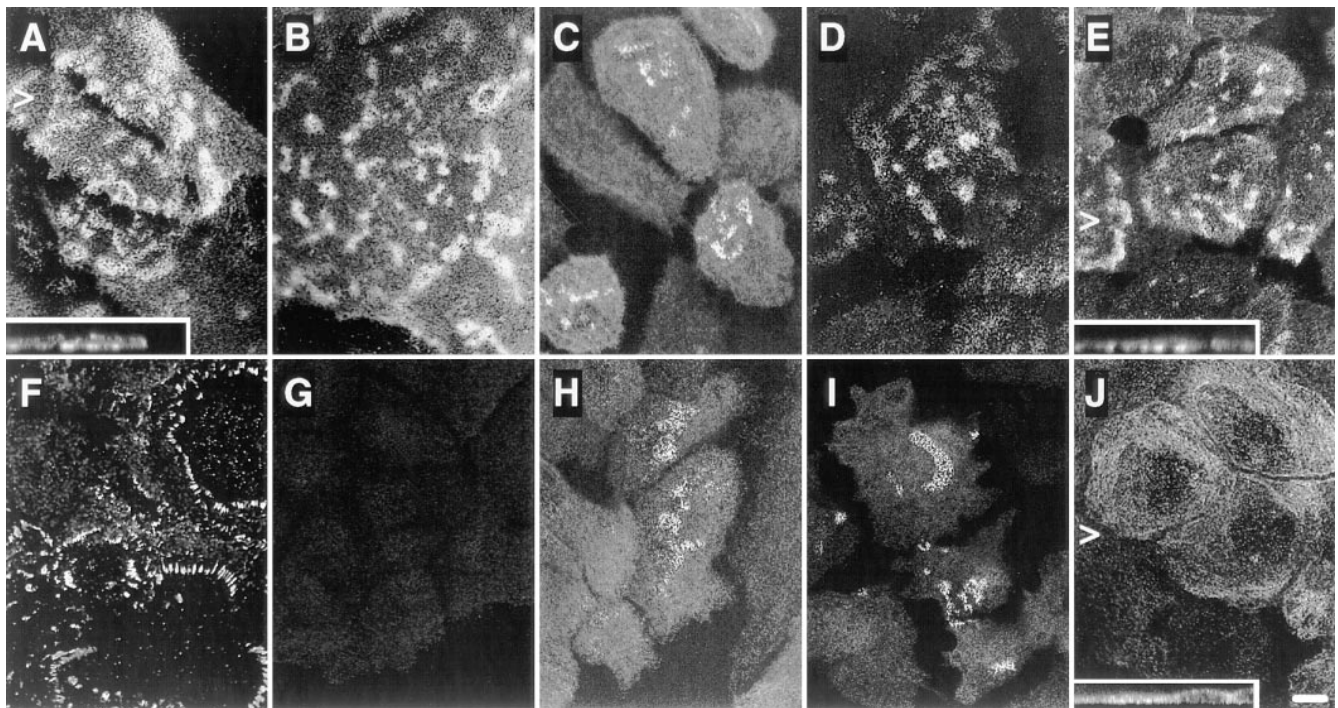

Figure 1. Immunolocalization of hemidesmosomal components in the NHK (A–E) and PA-JEB cell lines (F–J) by confocal laser microscopy. Cells were grown on glass coverslips in HAMF12/DME (1:3) medium, fixed, and immunolabeled using the rat mAb GoH3 directed against α 6 (A and F), the mAb 450-9D against β 4 (B and G), a rabbit anti-BP230 antiserum (C and H), the mAb 233 against BP180 (D and I), and the mAb 121 against HD1 (E and J). In NHK, the hemidesmosomal components are concentrated at sites of cell-substrate contact in patches characteristic for HD-like structures. In PA-JEB keratinocytes, only BP230 (H) and BP180 (I) are found concentrated in the rare HD-like structures in fewer than 1% of the cells. α 6 is colocalized with vinculin (data not shown) in dots and streaks representing focal adhesions (F), whereas HD1/plectin is found diffusely distributed throughout the cell (J). No β 4 reactivity is observed in PA-JEB cells (G). Sections were focused at the cell-substrate interface. Arrowheads, positions from which the perpendicular sections, shown in the insets, were taken. Bar, 10 μ m.

not shown), consistent with its localization in focal contacts in the parental PA-JEB cells (Niessen et al., 1996). In only a few cells (less than 1%) BP230 and BP180 were concentrated in HD-like structures at the basal cell surface (Fig. 1, *H* and *I*). However, whereas HD1/plectin was found in some HD-like structures in the primary PA-JEB keratinocytes (Niessen et al., 1996), it was completely absent from such structures in the immortalized cells (Fig. 1 *J*). These findings show that the formation of HD-like structures is impaired in the immortalized PA-JEB keratinocytes.

Coimmunoprecipitation of $\alpha 6$ with $\beta 1$ in PA-JEB Keratinocytes

The expression profile of integrins was determined by immunoprecipitation of ^{125}I surface-labeled PA-JEB keratinocytes and NHK (Fig. 2). The mAb against $\alpha 6$ precipitated this subunit associated with $\beta 4$ from NHK (Fig. 2, *left*), whereas $\alpha 6$ and $\beta 1$, but not $\beta 4$, were precipitated from the PA-JEB keratinocytes (Fig. 2, *right*). $\beta 1$ was co-precipitated together with $\alpha 2$, $\alpha 3$, $\alpha 5$, and $\alpha 6$ from the PA-JEB keratinocytes, but only with $\alpha 2$, $\alpha 3$, and $\alpha 5$ from the NHK. These results demonstrate that although NHK express $\alpha 6\beta 4$, PA-JEB keratinocytes express $\alpha 6\beta 1$ on their surface. In addition, no $\beta 4$ was detected by flow cytometry on the surface of PA-JEB keratinocytes, whereas the expression level of $\alpha 6$ was substantially decreased as com-

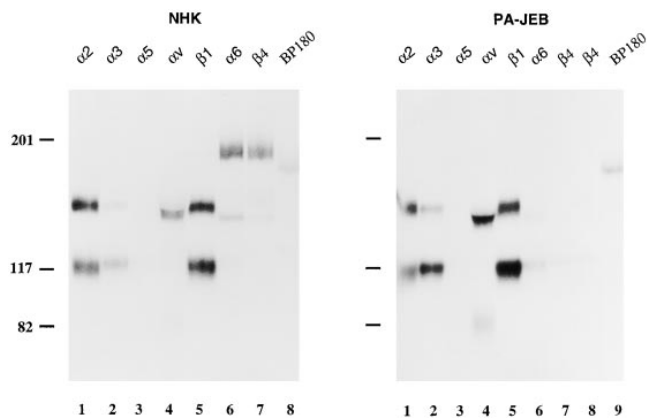

Figure 2. Immunoprecipitation of integrin complexes and BP180 from NHK and PA-JEB keratinocytes. Lysates of ^{125}I -labeled NHK (*left*) and PA-JEB keratinocytes (*right*) were immunoprecipitated with the mAbs P1E6 (against $\alpha 2$, lane 1), J143 ($\alpha 3$, lane 2), Sam-1 ($\alpha 5$, lane 3), NKI-M9 ($\alpha 6$, lane 4), J8H ($\alpha 6$, lane 5), TS2/16 ($\beta 1$, lane 6), 450-9D ($\beta 4$, lane 7), 439-9B ($\beta 4$, lane 8, *right*) and 1D1 (BP180, lane 8, *left* and lane 9, *right*, respectively). The antibody against $\alpha 6$ precipitated this subunit associated with $\beta 4$ from NHK, whereas from the PA-JEB cells $\alpha 6$ and $\beta 1$ were precipitated, but not $\beta 4$. The faint band which migrates just above $\beta 1$ and seen in the lanes containing the anti- $\beta 4$ immunoprecipitates from PA-JEB cells, represents a nonspecific product. $\beta 1$ is found in association with $\alpha 2$, $\alpha 3$, $\alpha 5$, and $\alpha 6$ in PA-JEB cells, but only with $\alpha 2$, $\alpha 3$, and $\alpha 5$ in NHK. Precipitation of $\beta 1$ with $\alpha 5$ is evident after prolonged exposure (data not shown). Samples were analyzed on a SDS-polyacrylamide (5%) gel under nonreducing conditions. The positions of molecular weight standards (in kD) are indicated on the left.

pared to that on NHK (data not shown). The $\alpha 6$ subunit was precipitated from both cell lines (Fig. 2) and was associated with both $\beta 3$ and $\beta 5$ subunits (data not shown).

Reexpressed $\beta 4$ in PA-JEB Keratinocytes Is Associated with $\alpha 6$ and Induces the Formation of HD-like Structures

To restore expression of $\beta 4$, the PA-JEB keratinocytes were transiently transfected with cDNA encoding wild-type $\beta 4$ (Fig. 3 *A*). Immunoprecipitation analysis of lysates of radiolabeled transfected PA-JEB keratinocytes is shown in Fig. 4. A mAb against $\beta 4$ precipitated $\beta 4$ and $\alpha 6$ from transfected PA-JEB keratinocytes (Fig. 4, *right*), but not from untransfected cells (Fig. 4, *middle*). Thus, $\beta 4$ is expressed and forms a heterodimer with endogenous $\alpha 6$ in the transfected cells, as in NHK (Fig. 4, *left*).

The subcellular distribution of the newly synthesized $\beta 4$ in transfected PA-JEB keratinocytes was assessed by confocal immunofluorescence microscopy. In transfected cells, $\beta 4$ (i.e., $\beta 4A$ or $\beta 4B$ with a 53 amino acid insertion in the CS) was concentrated in HD-like structures at the basal side of the cell (Fig. 5, *A-E*), where it is colocalized with $\alpha 6$, BP180 and BP230 (Fig. 5, *F, I*, and *J*). In addition, HD1/plectin was no longer diffusely distributed in the cytoplasm, but colocalized with $\alpha 6\beta 4$ at cell-substrate contact sites (Fig. 5, *C* and *H*). Staining for vinculin revealed the presence of focal contacts organized at the periphery of the HD-like clusters (Fig. 5, *B* and *G*). We conclude that expression of $\beta 4$ restores the capacity of PA-JEB keratinocytes to form HD-like structures.

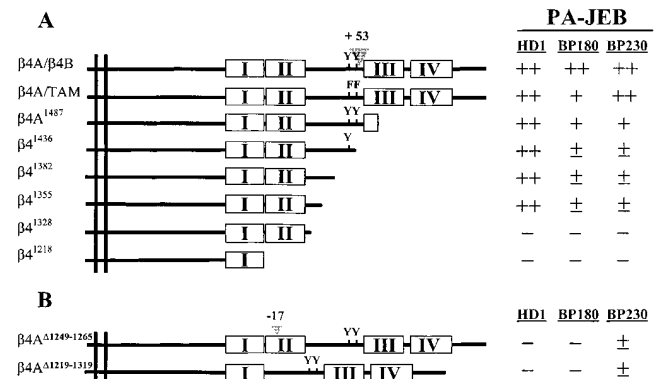

Figure 3. Expression of full-length, TAM-mutated, COOH-terminally truncated (*A*), and internal deletion mutant (*B*) $\beta 4$ cDNAs in PA-JEB keratinocytes. Schematic representation of the cDNA constructs encoding wild-type and mutant forms of $\beta 4$ carrying deletions of the cytoplasmic domain. Boxes, FNIII repeats in which the number of the repeat is shown; triangle, the $\beta 4B$ -specific insert of 53 amino acids in the CS (*A*), or the 17-amino acid deletion in the second FNIII repeat as described for a PA-JEB patient (Vidal et al., 1995) (*B*). Y > F mutations of the TAM are represented by F. The immunolocalizations of the hemidesmosomal components HD1/plectin, BP180, and BP230 were investigated upon transfection of the $\beta 4$ constructs in PA-JEB cells. Colocalization of HD1/plectin, BP180, and BP230, respectively, with $\alpha 6\beta 4$ at the basal cell surface in HD-like structures is observed in ++, 75–100%; +, 25–75%; ±, 1–25%; –, 0%, of the $\beta 4$ -transfected cells.

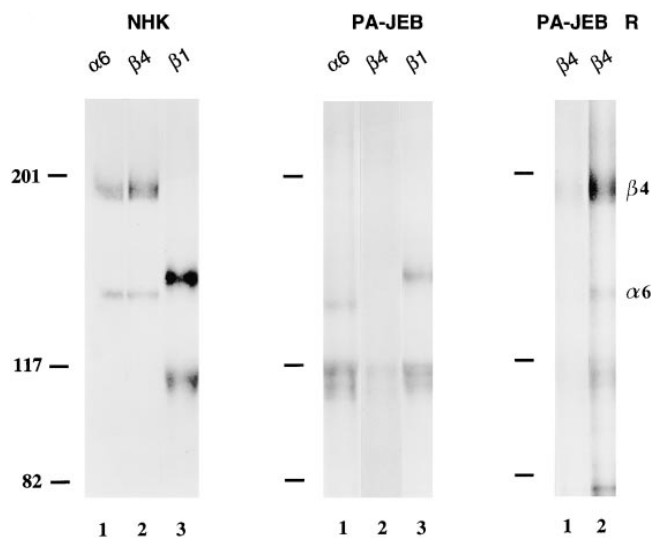

Figure 4. Immunoprecipitation analysis of PA-JEB keratinocytes transfected with cDNA encoding wild-type $\beta 4$ (*PA-JEB R*). Lysates of [35 S]methionine/cysteine-labeled NHK and PA-JEB cells were immunoprecipitated with the mAb J8H against $\alpha 6$ (lane 1), the anti- $\beta 4$ mAb 450-9D (lane 2), and the mAb TS2/16 against $\beta 1$ (lane 3). Antibodies against $\alpha 6$ precipitate $\alpha 6$ and $\beta 4$ from NHK, and $\alpha 6$ together with $\beta 1$ from PA-JEB cells. Antibodies against $\beta 4$ precipitate this subunit together with $\alpha 6$ from NHK, but not from PA-JEB cells. In contrast, from PA-JEB cells transfected with cDNA for $\beta 4$ (*PA-JEB R*) antibodies against $\beta 4$ (lane 1) precipitate $\beta 4$ together with $\alpha 6$. Coprecipitation of $\alpha 6$ is evident after prolonged exposure (lane 2). Samples were analyzed on a SDS-polyacrylamide (5%) gel under nonreducing conditions. The positions of molecular weight standards (in kD) are indicated on the left and those of the $\beta 4$ and $\alpha 6$ integrin subunits are indicated on the right.

The $\beta 4$ TAM Is Not Essential for the Formation of HD-like Structures

It has been suggested that phosphorylation of the TAM, which consists of two closely spaced tyrosine residues located at position 1,422 and 1,440 within the CS of the $\beta 4$ cytoplasmic domain, is critical for the incorporation of $\alpha 6\beta 4$ in HDs and HD assembly (Mainiero et al., 1995). Therefore, we investigated whether expression of $\beta 4$ with a mutated TAM affected the formation of HD-like structures. $\beta 4$ with phenylalanine substitutions in the TAM was concentrated at the basal side of the cells (Fig. 6, A, C, E, and G) together with $\alpha 6$, HD1/plectin, BP180, and BP230 (Fig. 6, B, D, F, and H, respectively) in a pattern indistinguishable from that seen upon transfection with wild-type $\beta 4$ cDNA (Fig. 5). However, compared to wild-type $\beta 4$, TAM-mutated $\beta 4A$ appeared to have a reduced ability to induce redistribution of BP180 to the basal side of the cell, because in $\sim 30\%$ of the transfected cells the distribution of BP180 remained diffuse throughout the cell. Thus, although the $\beta 4A$ TAM may influence the association of BP180 with HDs, it is largely dispensable for the assembly of these structures.

Identification of Sequences within the $\beta 4$ Cytoplasmic Domain Involved in the Recruitment of HD1/Plectin, BP180, and BP230 to HD-like Structures

Previous studies have shown that the sequences within the $\beta 4$ cytoplasmic domain that are responsible for inducing the redistribution of HD1/plectin in COS-7 cells and mouse embryonic fibroblasts are also sufficient to incorporate $\beta 4$ mutants into existing HDs in 804G rat bladder carcinoma cells (Niessen et al., 1997a; Sánchez-Aparicio et al., 1997). To identify the specific regions required for HD formation, we assessed the distribution of HD1/plectin, BP180, and BP230

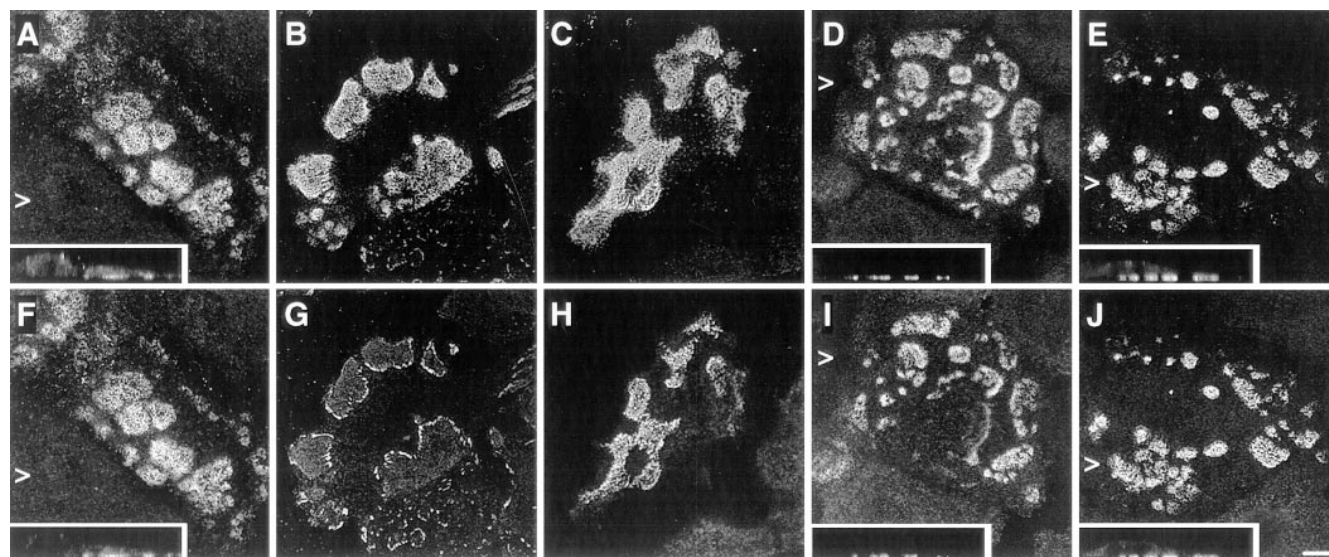

Figure 5. Expression of wild-type $\beta 4$ in PA-JEB keratinocytes induces the formation of HD-like structures. PA-JEB cells were transfected with cDNA encoding $\beta 4A$. After 36 h, cells were fixed, permeabilized, and subjected to double labeling immunofluorescence for $\beta 4$ (A–E) and $\alpha 6$ (F), vinculin (G), HD1/plectin (H), BP180 (I), and BP230 (J). Upon transfection, expression of $\beta 4$ results in the formation of HD-like structures, in which $\beta 4$ is concentrated at sites of cell–substrate contact and codistributed with $\alpha 6$, HD1/plectin, BP180, and BP230 (insets are the perpendicular sections). In cells expressing $\beta 4$, $\alpha 6$ is now found in HD-like structures (F), and no longer concentrated in focal adhesions at the outer periphery of these structures, as shown by staining for vinculin (G). Bar, 10 μ m.

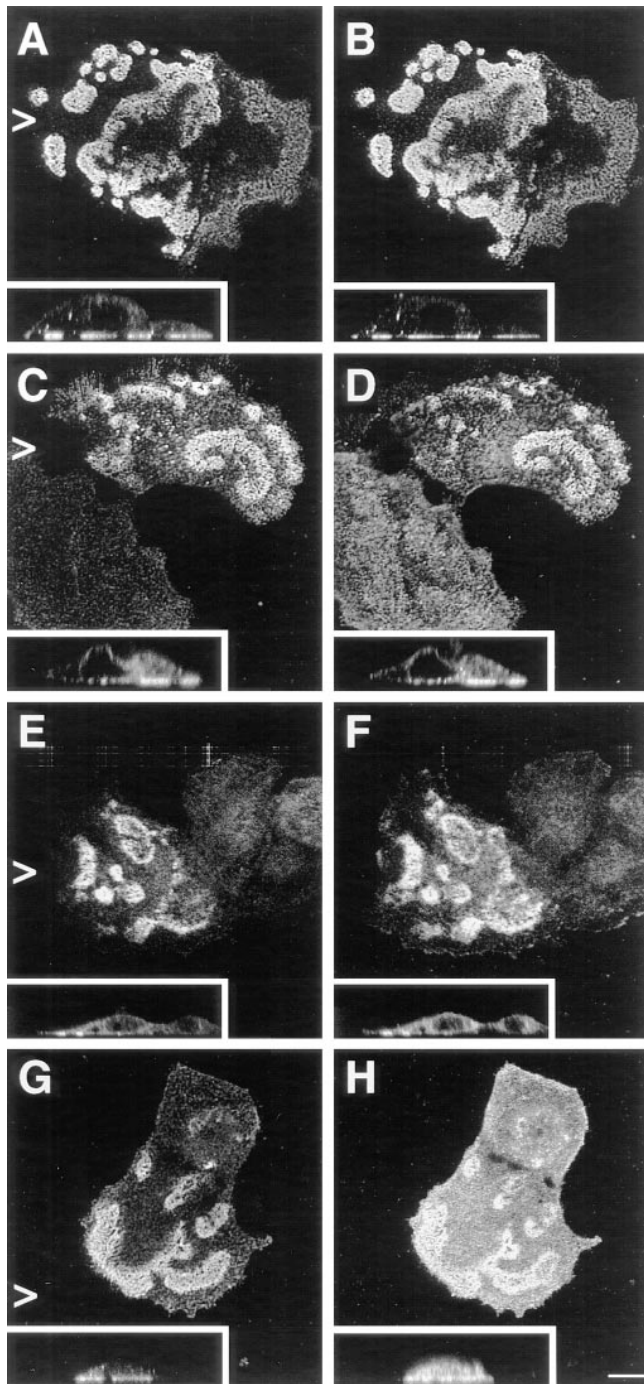

Figure 6. Expression of a $\beta 4$ TAM mutant induces the assembly of HD-like structures in transfected PA-JEB keratinocytes. PA-JEB cells transfected with TAM-mutated $\beta 4A$ cDNA were double stained for $\beta 4$ (A, C, E, and G) and $\alpha 6$ (B), HD1/plectin (D), BP180 (F), and BP230 (H). As shown in the perpendicular sections, a $\beta 4$ molecule with phenylalanine substitutions at the TAM becomes localized together with $\alpha 6$ at the basal cell side and recruits HD1/plectin, BP180, and BP230 to sites of cell–substrate contact. The redistribution of BP180 was, however, slightly impaired. Bar, 10 μm .

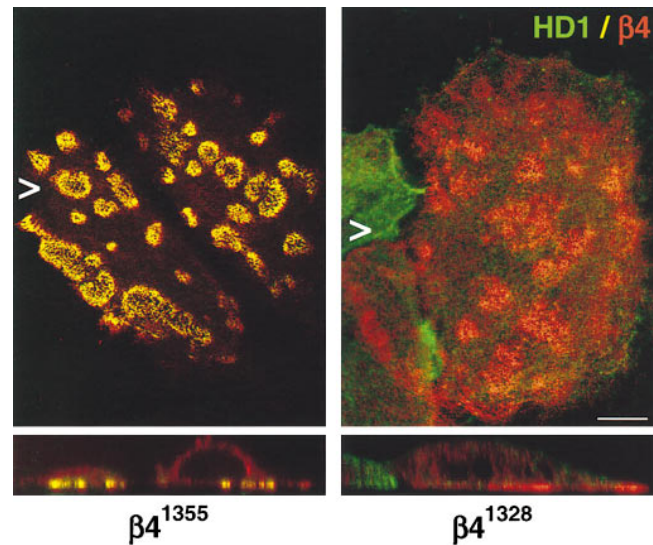

Figure 7. A segment comprising the first pair of FNIII repeats and a 27-amino acid stretch of the CS is essential for the localization of HD1/plectin at the basal cell surface. Representatives of double immunofluorescence analyses of PA-JEB cells transfected with cDNA encoding COOH-terminal deletion mutants of $\beta 4$ as depicted in Fig. 3 are shown. PA-JEB cells transfected with cDNA coding for $\beta 4^{1,355}$ or $\beta 4^{1,328}$ were immunolabeled with antibodies against $\beta 4$ (red) and HD1 (green). Although $\beta 4^{1,355}$ still induces the redistribution of HD1/plectin to the basal surface of the cell (left), $\beta 4^{1,328}$, lacking an additional 27 amino acids of the CS does not affect the distribution of HD1/plectin (right). Noteworthy, the distribution pattern of $\alpha 6\beta 4$ in the absence of HD1/plectin is comparable to that of $\alpha 6\beta 4$ together with HD1/plectin and indistinguishable by confocal microscopy. Bar, 10 μm .

in PA-JEB cells transfected with mutant $\beta 4$ cDNAs. We found that the NH_2 -terminal, but not the COOH-terminal half of the $\beta 4$ cytoplasmic domain, is involved in the recruitment of HD1/plectin to areas of cell–substrate contact in PA-JEB cells (refer to Fig. 3 A). Transfection of PA-JEB cells with the various cDNAs encoding COOH-terminal deletion mutants of $\beta 4$ showed that the segment comprising the first pair of FNIII repeats and a stretch of 27 amino acids in the CS contains sequences that critically affect the distribution of HD1/plectin (Fig. 3 A and Fig. 7).

Since the COOH-terminal half of the $\beta 4$ cytoplasmic domain has previously been shown to be responsible for the localization of BP180 in transfected COS-7 cells (Boradori et al., 1997), we investigated whether $\beta 4$ mutants with increasing COOH-terminal truncations were able to recruit BP180 and BP230 into newly formed HD-like structures. In contrast to its effect on the localization of HD1/plectin, truncation after amino acid 1,487 ($\beta 4A^{1,487}$) already reduced the ability of the mutated $\beta 4$ molecules to localize BP180 and BP230 together with $\alpha 6\beta 4$ and HD1/plectin at the basal side of the cells (Fig. 3 A and Fig. 8). Progressive COOH-terminal truncations up to amino acid 1355 ($\beta 4^{1,355}$) resulted in a gradual increase in the percentage of $\beta 4$ -transfected cells in which BP180 and BP230 remained diffusely distributed throughout the cell (refer to Fig. 3 A). Furthermore, in cells expressing $\beta 4$ that was truncated after amino acid 1,328 ($\beta 4^{1,328}$), in which HD1/

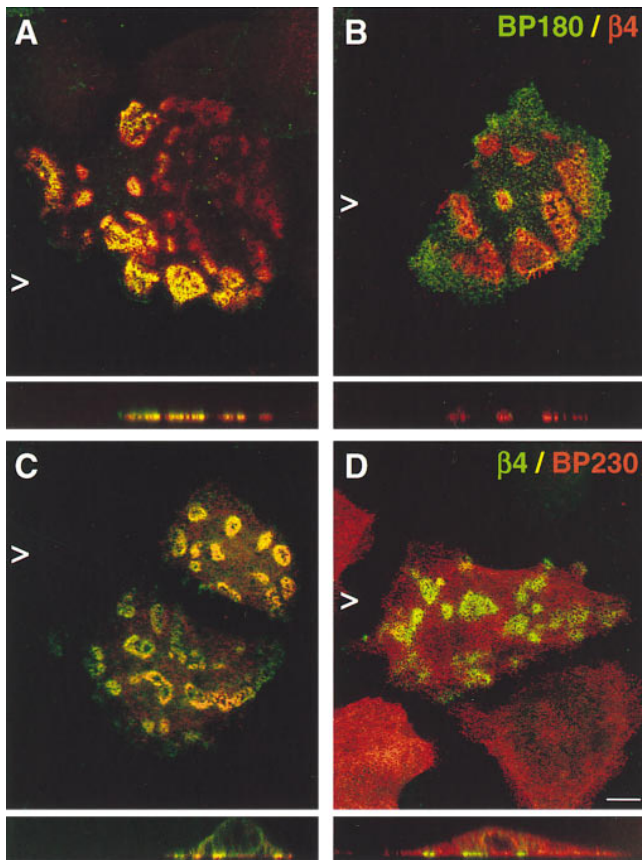

Figure 8. Distribution of BP180 and BP230 in PA-JEB keratinocytes is affected by COOH-terminal truncations of $\beta 4$. PA-JEB cells transfected with cDNA encoding mutant forms of $\beta 4$ were double-stained for $\beta 4$ (red) and BP180 (green) (A and B) or for $\beta 4$ (green) and BP230 (red) (C and D). Shown are representatives of transfections with $\beta 4^{1.436}$ cDNA. Truncation of the second pair of FNIII repeats already impairs the recruitment of BP180 (B) and BP230 (D) to the basal cell surface, although cells showing colocalization of the BP antigens with $\beta 4$ can readily be found (A and C). Increasing COOH-terminal truncations further impair the localization of BP180 and BP230 at the basal cell side (refer to Fig. 3 A). In cells transfected with $\beta 4^{1.328}$ cDNA, which also do not show basal localization of HD1/plectin, BP180 and BP230 remain diffusely distributed throughout the cell (data not shown). Bar, 10 μ m.

plectin was no longer concentrated together with $\alpha 6\beta 4$ at the basal side of the cell, BP180 and BP230 were also diffusely distributed throughout the cell. These results suggest that sequences within the CS and the second pair of FNIII repeats of $\beta 4$ are involved in targeting BP180 and BP230 into HD-like structures. In addition, the presence of HD1/plectin at the basal cell surface appears to be crucial for these translocation events as well (see also below).

Interaction between $\beta 4$ and BP180 in COS-7 Cells

To test whether $\beta 4$ interacts with BP180 in mammalian cells, we have performed immunoprecipitation and immunoblotting experiments using lysates from COS-7 cells that were transfected with cDNAs encoding $\alpha 6A$ and FLAG-tagged BP180 (clone B, BP180 $^{\Delta 521-1,497}$) together with vari-

ous $\beta 4$ mutants. As shown in Fig. 9, $\beta 4$ is present in anti-FLAGTM M2 immunoprecipitates from lysates of cells transfected with cDNAs for $\alpha 6A$, $\beta 4A$, and BP180 (Fig. 9, top, lane 4). Furthermore, in agreement with our localization studies, small amounts of $\beta 4^{1.355}$ mutant protein were co-precipitated by anti-FLAGTM M2 antibodies (Fig. 9, top, lane 6). As expected, the $\beta 4^{1.328}$ mutant protein was not detectable in these immunoprecipitates (Fig. 9, top, lane 8), although equal amounts of mutant BP180 molecules were precipitated by the anti-FLAGTM M2 antibodies from the cells transfected with the corresponding cDNAs (Fig. 9, bottom). Together, these data reveal that $\beta 4$ and BP180 are present in immune complexes and support the results obtained with the localization studies in PA-JEB cells.

Direct Interaction between the Cytoplasmic Domains of $\beta 4$ and BP180

To investigate whether the cytoplasmic domains of $\beta 4$ and BP180 can directly bind to each other, and to determine which site on $\beta 4$ is involved in this interaction, a yeast two-hybrid assay (Fields and Song, 1989) was performed (Fig. 10). Yeast strain PJ69-4A was cotransformed with the GAL4(AD) pACT2 and the GAL4(BD) pAS2-1 vectors or derivatives thereof. For several pACT2- $\beta 4$ plasmids, cotransformation of the yeast strain together with the pAS2-BP180 plasmid (and only then) supported growth of colonies on SC-LTHA plates, showing that the His and Ade reporter genes in these yeast cells were activated by a direct interaction between the BP180- and $\beta 4$ -GAL4 fusion proteins. The highest plating efficiency on SC-LTHA plates was observed with the $\beta 4^{1.115-1.666}$ construct (both the $\beta 4A$ and the $\beta 4B$ splice variant). The number and growth rate of the colonies on SC-LTHA plates were comparable to those on SC-LT plates, indicating that both reporter genes were efficiently expressed as a result of a strong interaction between $\beta 4$ and BP180 (refer to Materials and Methods). In fact, the plating efficiency was com-

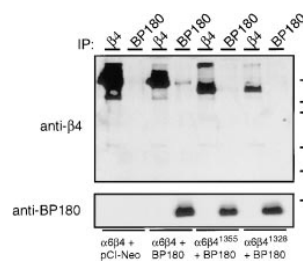

Figure 9. Coimmunoprecipitation of $\beta 4$ and BP180. Lysates of COS-7 cells cotransfected with cDNAs for $\alpha 6A$ and wild-type $\beta 4A$, $\beta 4^{1.355}$, or $\beta 4^{1.328}$ as well as an empty pCI-Neo vector or a pCI-Neo construct encoding the BP180 cytoplasmic domain were subjected to immunoprecipitation with a mixture

(1:1:1) of three anti- $\beta 4$ mAbs, 4.3E1, 113C and 450-9D, respectively, or with the mAb FLAGTM M2. Samples were resolved on a SDS-polyacrylamide (8%) gel under nonreducing conditions. Shown is an immunoblot analysis developed with the rabbit polyclonal anti-serum against $\beta 4$ (top) and the mAb FLAGTM M2 to detect BP180 (bottom) among the immunoprecipitated proteins. When samples immunoprecipitated with the anti- $\beta 4$ mAbs were subjected to immunoblotting with the mAb FLAGTM M2 (bottom) or a polyclonal anti-BP180 antiserum (data not shown), the mutant form of BP180 was not detectable in the anti- $\beta 4$ immunoprecipitates. The positions of molecular weight standards (in kD) are indicated on the right.

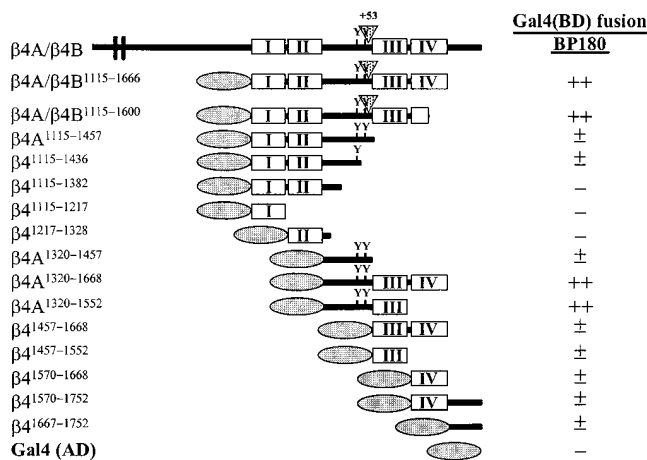

Figure 10. Survey of the sites of interaction between the cytoplasmic domains of $\beta 4$ and BP180. Yeast strain PJ69-4A was cotransformed with pAS2-BP180 and one of each of the listed pACT2- $\beta 4$ constructs, or with an empty pACT2. Transformation mixtures were spread on SC-LT and SC-LTHA plates and grown for 9 d at 30°C. Plating efficiency on SC-LTHA plates is expressed relative to that on SC-LT plates of the same transformation. ++, >50%; ±, 5–25%; and –, 0% indicate relative efficiencies, respectively. Plates were scored after 4 and 9 d of growth. Plating efficiencies above 25% represent fast-growing colonies that could be scored after 4 d; plating efficiencies lower than 25% represent colonies that clearly grow more slowly and could only be scored after 9 d of growth. All efficiencies listed represent an average of multiple independent transformation experiments on at least three separate days. Cotransformation efficiencies (on SC-LT plates) for all plasmid combinations listed were always at least 10^4 cfu/ μ g, and the difference between the various $\beta 4$ plasmids tested never was greater than twofold. Cotransformation of yeast PJ69-4A with empty pAS2-1 and pACT2 vectors never resulted in the growth of colonies on SC-LTHA plates, nor did cotransformation of the yeast strain with either the pAS2-BP180 plasmid and an empty pACT2 vector or any of the pACT2- $\beta 4$ plasmids and an empty pAS2-1 vector, showing that none of the GAL4 fusion proteins encoded by these recombinant plasmids by themselves could cause activation of the His and Ade reporter genes.

parable to that of the pCL1/pAS2-1 and pTD1-1/pVA3-1 positive controls.

The site of interaction was mapped using $\beta 4$ with COOH-terminal deletions. Removal of the COOH terminus together with the second part of the fourth FNIII repeat, $\beta 4^{1,115-1,666}$ (again for both the $\beta 4A$ and $\beta 4B$ splice variants), resulted in only a slight decrease in the plating efficiency and growth rate. However, COOH-terminal deletions up to the end of the CS ($\beta 4A^{1,115-1,457}$) resulted in a dramatic reduction in binding. Truncation up to the last 21 amino acids of the CS ($\beta 4^{1,115-1,436}$) had no effect on the binding, but there was no binding at all when 54 additional residues were deleted ($\beta 4^{1,115-1,382}$). These results suggest that the main binding sites for BP180 on $\beta 4$ reside in the segment comprising the COOH-terminal half of the CS and the third FNIII repeat.

To confirm this finding, fragments of the $\beta 4$ cytoplasmic domain were used. As expected, deletion of the first two FNIII repeats ($\beta 4A^{1,320-1,668}$) did not result in decreased binding to BP180, as compared to $\beta 4A^{1,115-1,666}$. The same

was found for binding of BP180 to $\beta 4A^{1,320-1,552}$, compared to $\beta 4^{1,115-1,600}$. Accordingly, neither the first ($\beta 4^{1,115-1,217}$) nor the second ($\beta 4^{1,217-1,328}$) FNIII repeat can bind to BP180. Efficient binding to BP180 was only observed when both the CS and the third FNIII repeat were present ($\beta 4A^{1,320-1,552}$). The third or fourth FNIII repeat or the COOH terminus alone ($\beta 4^{1,457-1,552}$, $\beta 4^{1,570-1,668}$, and $\beta 4^{1,667-1,752}$, respectively) showed only weak binding. The results obtained with the yeast two-hybrid assay are in good agreement with those obtained with the cell transfection studies (as shown above), and conclusively prove that $\beta 4$ interacts directly with BP180.

A Role for HD1/Plectin in the Localization of BP180

The presence of small amounts of $\beta 4^{1,355}$ protein, which does not contain the BP180 binding site(s), in the BP180 immunoprecipitate may have been due to the presence of HD1/plectin in these immune complexes. To determine whether HD1/plectin play a role in the recruitment of BP180 into HDs, we assessed the localization of BP180 in PA-JEB cells transfected with cDNAs encoding $\beta 4$ mutants that lack sequences essential for the recruitment of HD1/plectin ($\beta 4A^{\Delta 1,219-1,319}$ and $\beta 4A^{\Delta 1,249-1,265}$; Fig. 3 B). Neither of the $\beta 4$ mutants induced a redistribution of HD1/plectin, despite the fact that they were able to cluster with $\alpha 6$ at the basal side of the cells (Fig. 11 A). Remarkably, in the absence of HD1/plectin, but in the presence of the binding sites for BP180 on $\beta 4$, BP180 was not recruited to the basal cell surface but remained diffusely distributed (Fig. 11 B). Thus, in addition to $\beta 4$, HD1/plectin is essential for the recruitment of BP180 into HD-like structures.

It is noteworthy that in a few cases (i.e., <25% of transfected cells) these $\beta 4$ mutants recruited BP230 in an HD1/plectin- and BP180-independent manner to the basal cell surface (Fig. 11 C). These results together with the results obtained with the COOH-terminal truncation mutants suggest a BP180-independent, (in)direct interaction between $\beta 4$ and BP230.

Intramolecular Interactions in the $\beta 4$ Cytoplasmic Domain

The observation that the $\beta 4$ internal deletion mutants which lack the HD1/plectin binding site(s), but possess the binding sites for BP180 failed to recruit BP180, prompted us to investigate whether the NH₂- and the COOH-terminal parts of the $\beta 4$ cytoplasmic domain interact with each other. Such an intramolecular interaction might prevent the interaction with BP180 and proffer an explanation for the essential role of HD1/plectin in the interaction of $\beta 4$ with BP180. The potential intramolecular interaction was tested in a yeast two-hybrid assay in which the GAL4 activation and DNA-binding domains were fused to various parts of the $\beta 4$ cytoplasmic domain (Fig. 12).

A $\beta 4^{1,457-1,752}$ cDNA was cloned into the pAS2-1(BD) vector and cotransformed to yeast in combination with an empty pACT2 vector (to check for autonomous transactivation) or with a pACT2-derivative containing diverse $\beta 4$ inserts. Strong binding was observed with $\beta 4$ (AD) constructs $\beta 4A^{1,115-1,457}$ and $\beta 4^{1,115-1,436}$ that contained the first two FNIII repeats together with a large part of the connecting region (Fig. 12, top). Binding was strongly, but not

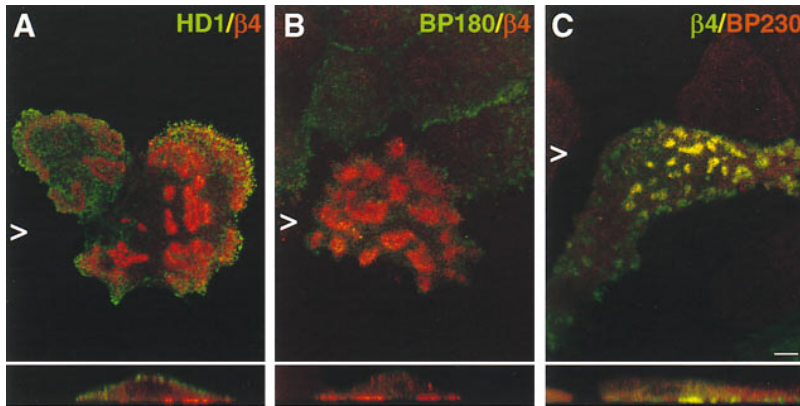

Figure 11. Basal localization of HD1/plectin together with $\beta 4$ is essential for the recruitment of BP180. PA-JEB cells transfected with cDNA encoding internal deletion mutants of $\beta 4$ were double-stained for (A) $\beta 4$ (red) and HD1/plectin (green), (B) $\beta 4$ (red) and BP180 (green), and (C) $\beta 4$ (green) and BP230 (red). Shown are representatives of transfections with $\beta 4A^{\Delta 1,249-1,265}$. Deletion of 17 amino acids in the second FNIII repeat or its complete deletion prevent the recruitment of HD1/plectin (A). As a consequence, $\alpha 6\beta 4$ clustered at the basal cell surface is no longer capable of recruiting BP180 to these HD1/plectin-lacking clusters although the binding sites for BP180 are still present (B). In a few cases (i.e., <25% of $\beta 4$ -transfected cells) these $\beta 4$ mutants were able to recruit BP230 in an HD1/plectin- and BP180-independent manner to the basal cell surface (C). Bar, 10 μm .

completely reduced by deletion of the first and second FNIII repeat ($\beta 4A^{1,320-1,457}$). No binding could be demonstrated with either the first or the second FNIII repeat alone ($\beta 4^{1,115-1,217}$ and $\beta 4^{1,217-1,328}$, respectively). To determine which part of the $\beta 4$ COOH terminus binds to the more NH₂-terminal part ($\beta 4^{1,115-1,436}$), the smaller COOH-terminal $\beta 4$ subclones as shown in Fig. 10 were excised from the pACT2(AD) vector and recloned in the pAS2-1(BD) vector. Subsequently, the resulting $\beta 4$ (BD) constructs were cotransformed to yeast in combination with an empty pACT2 vector (to check for autonomous transactivation) or with a pACT2-derivative containing the $\beta 4^{1,115-1,436}$ insert (Fig. 12 bottom). The results show that only the COOH-terminal part of the $\beta 4$ cytoplasmic domain strongly interacted with the $\beta 4^{1,115-1,436}$ sequence, whereas the third and fourth FNIII repeat had no apparent role in this intramolecular association. These observations together with the results of the cell biological studies described in the previous paragraph suggest that the $\beta 4$ protein can fold back upon itself, with the COOH-termi-

nal 85 amino acids binding to the HD1/plectin-binding region located further NH₂-terminal.

Discussion

The $\beta 4$ Integrin Subunit Is Critical for the Formation of HD-like Structures

We have established an immortalized keratinocyte cell line from a PA-JEB patient lacking $\beta 4$ expression (Niessen et al., 1996). Only a few of these cells have low numbers of disorganized HD-like structures that contain the hemidesmosomal components BP180 and BP230, but not $\alpha 6$ or HD1/plectin. Whereas $\alpha 6$ is concentrated in focal contacts, HD1/plectin is diffusely distributed in the cytoplasm. Our results demonstrate that transfection of these PA-JEB keratinocytes with cDNA encoding wild-type $\beta 4$ results in the reexpression of the protein that is correctly associated with $\alpha 6$ and is clustered in patches at the basal cell surface. Most strikingly, restored expression of $\beta 4$ results in the formation of organized HD-like structures that contain, in addition to the $\alpha 6\beta 4$ integrin, the hemidesmosomal elements HD1/plectin, BP180 and BP230. These HD-like structures are encircled by focal contacts in a pattern indistinguishable from that observed in cultured normal human keratinocytes (Carter et al., 1990; Marchisio et al., 1990). These findings demonstrate that expression of $\beta 4$ affects the subcellular localization of various hemidesmosomal components, suggesting that it recruits these components to HD-like structures.

Previous electron microscopical studies have shown that PA-JEB patients exhibit hypoplastic HDs with poorly developed attachment plaques and subbasal dense plates (Vidal et al., 1995; Niessen et al., 1996). Our results provide additional support for a crucial role of $\alpha 6\beta 4$ in the formation and organization of HDs. It is noteworthy that, in contrast to our findings in vitro, HD1/plectin, BP180, and BP230 appeared to be correctly localized at sites of cell-substrate contact in the skin of this PA-JEB patient (Niessen et al., 1996). The different localization of these proteins in vitro is puzzling, but may reflect the inability of the immortalized PA-JEB cells to synthesize the ligand(s)

	Gal4(BD) fusion $\beta 4^{1457-1752}$
$\beta 4A^{1115-1457}$	++
$\beta 4^{1115-1436}$	++
$\beta 4^{1115-1382}$	±
$\beta 4^{1115-1217}$	-
$\beta 4^{1217-1328}$	-
$\beta 4A^{1320-1457}$	±
Gal4 (AD)	-

	Gal4(AD) fusion $\beta 4^{1115-1436}$
$\beta 4^{1457-1752}$	++
$\beta 4^{1570-1752}$	++
$\beta 4^{1667-1752}$	++
$\beta 4^{1457-1668}$	-
$\beta 4^{1457-1552}$	-
$\beta 4^{1570-1668}$	-
Gal4 (BD)	-

Figure 12. Intramolecular interactions in the $\beta 4$ cytoplasmic domain. Yeast strain PJ69-4A was cotransformed with two different $\beta 4$ constructs as listed. Other details are as in Fig. 10, except that the efficiencies represent an average of multiple independent transformation experiments on at least two separate days.

for BP180 which normally induces its correct polarization at the basal cell surface via a ligand–receptor interaction.

Signaling via the $\beta 4$ TAM Is Dispensable for the Formation of HD-like Structures

Mutagenesis experiments have suggested that phosphorylation of the $\beta 4$ TAM is required for the formation of HDs in 804G rat bladder carcinoma cells, since a $\beta 4$ molecule with phenylalanine substitutions in the TAM was not incorporated in HDs (Mainiero et al., 1995). However, using the same cells we could not reproduce these results (Niessen et al., 1997a). Consistent with and in extension to that observation, we here show that a $\beta 4$ molecule with a mutated TAM is able to initiate the assembly of well-organized HD-like structures containing HD1/plectin, BP180, and BP230 in PA-JEB keratinocytes. Nevertheless, in some cells expressing the $\beta 4$ TAM mutant, BP180 remained diffusely distributed. This observation is in agreement with recently published results suggesting that mutations in the $\beta 4$ TAM affect the localization of BP180 in COS-7 cells (Borradori et al., 1997). Together, our findings do not support the supposition that the TAM is critical for the formation of HDs.

Multiple Interactions between $\beta 4$, HD1/Plectin, and BP180

Sequences within $\beta 4$, encompassing the second FNIII repeat and a stretch of 27 amino acids of the CS, have previously been shown to be required for the localization of $\alpha 6\beta 4$ in HDs of 804G cells that endogenously express $\beta 4$ (Niessen et al., 1997a). These sequences are also important for the localization of HD1/plectin into junctional complexes containing $\alpha 6\beta 4$ (Niessen et al., 1997a; Sánchez-Aparicio et al., 1997). Our present study indicates that this same region is critical for initiating the formation of HD-like structures in PA-JEB keratinocytes. In contrast to the abrupt loss of HD1/plectin recruitment when $\beta 4$ is truncated after amino acid 1328 ($\beta 4^{1,328}$), increasing COOH-terminal truncations of $\beta 4$ appeared to gradually decrease the capacity of these mutants to redistribute BP180 and BP230 in PA-JEB cells.

We show here that the effect of $\beta 4$ on the subcellular localization of BP180 in both transfected PA-JEB keratinocytes (this study) and COS-7 cells (Borradori et al., 1997) is due to its direct binding to BP180. Using the yeast two-hybrid system, we have identified major binding sites for BP180 in a segment comprising the COOH-terminal half of the CS and the third FNIII repeat. The interaction with BP180 of either the CS or the third FNIII repeat alone was only weak. In accordance with these results, $\beta 4$ mutants with truncations in this region exhibited a reduced capacity to recruit BP180, as assessed by immunofluorescence analysis. Surprisingly, $\beta 4$ mutants that lacked the sequences critical for localization of HD1/plectin (i.e., the first pair of FNIII repeats and 27 amino acids of the CS) were no longer able to recruit BP180, even though they contained the BP180 binding site(s). These findings suggest that the recruitment of BP180 into HDs requires the interaction of BP180 with both $\beta 4$ and HD1/plectin. Three observations support this hypothesis. First, prelimi-

nary studies using the yeast two-hybrid system demonstrate a direct interaction between HD1/plectin and BP180 (Aho, S., and J. Uitto. 1997. *J. Invest. Dermatol.* 108:546a). Second, BP180 is not localized in HD-like structures at the basal cell side in keratinocytes derived from an epidermolysis bullosa simplex with muscular dystrophy patient lacking HD1/plectin (Gache et al., 1996). Finally, our immunoprecipitation analysis of transfected COS-7 cells showed the presence of the mutant $\beta 4^{1,355}$ protein, containing the HD1/plectin-binding region but lacking the binding sites for BP180, in the BP180 immunoprecipitate. In contrast, coimmunoprecipitation of a $\beta 4^{1,328}$ mutant which is no longer able to recruit HD1/plectin, was not observed. Although the presence of HD1/plectin in these immune complexes could not be assessed due to the lack of a suitable antibody which efficiently detects monkey HD1/plectin on immunoblots, these observations provide indirect evidence for an association of BP180 with both $\beta 4$ and HD1/plectin.

The finding that the efficient localization of BP180 into HDs seemed to depend on its interaction with at least two different hemidesmosomal components is not without precedent. The linkage of keratin filaments to the hemidesmosomal plaque involves the contribution of the two IF-binding proteins, HD1/plectin and BP230 (Foisner et al., 1988; Yang et al., 1996). Deletion of one of these molecules is not compensated by the remaining components and disturbs the anchorage of the keratin filaments to the hemidesmosomal plaque (Guo et al., 1995; Gache et al., 1996; McLean et al., 1996; Smith et al., 1996; Andrä et al., 1997). Thus, it is likely that proper assembly of HDs requires multiple interactions between the various components.

Recently, it was suggested that the incorporation of BP180 into HDs is facilitated by a direct interaction with the $\alpha 6$ integrin subunit (Hopkinson et al., 1995). Although it is not excluded that such an interaction may contribute to the stabilization of HDs, our results do not support this contention and they further show that the localization of BP180 clearly depends on distinct cytoplasmic regions of $\beta 4$ rather than $\alpha 6$. Even when $\alpha 6$ and the various $\beta 4$ mutants were clustered at the basal cell surface, BP180 remained diffusely distributed. In addition, we recently found that chimeric proteins consisting of the extracellular and transmembrane domains of the interleukin 2 receptor and the cytoplasmic domain of $\beta 4$ recruit BP180 to the basal cell surface in a laminin-5- and $\alpha 6$ -independent manner (Nievers et al., 1998).

The translocation of BP180 to the preexisting complex consisting of $\beta 4$ and HD1/plectin at the basal cell surface may constitute an intermediate step in the nucleation of HD-like structures and precede the localization of BP230 (this study; Gagnoux-Palacios et al., 1997). Indeed, restored synthesis of BP180 in keratinocytes, derived from a patient suffering from generalized atrophic benign epidermolysis bullosa associated with a deficiency for BP180, affected the subcellular localization of BP230. BP230 was no longer diffusely distributed in the cytoplasm, but was found together with BP180 at the basal surface of the transfected cells (Borradori et al., 1998). However, it is possible that additional pathways exist regulating the distribution of BP230, as inferred from the observation that expression of $\beta 4$ with a mutated TAM, appeared to impair

the recruitment of BP180 but not of BP230, into HD-like structures. Furthermore, a BP180-independent redistribution of BP230 was observed in ~10–20% of the cells transfected with the $\beta 4$ internal deletion mutants. The partial redistribution which is seen of BP180 and BP230 upon transfection of some $\beta 4$ mutants may also be due to compensatory mechanisms present in some cells but absent in others. This would mean that other proteins critical for hemidesmosome assembly are yet to be detected.

Are the $\beta 4$ Binding Sites for BP180 Masked by an Intramolecular Interaction?

As has been described for vinculin (Johnson and Craig, 1995; Gilmore and Burridge, 1996) and the ERM protein family (Bretscher et al., 1997), conformational activation of proteins appears to be a mechanism by which the assembly of cell surface structures can be regulated. The results of our transfection studies and the observation by others that BP180 is not localized at the basal cell surface in HD1/plectin-deficient keratinocytes (Gache et al., 1996) raise the intriguing possibility that HD1/plectin contributes to the formation of HDs not only by providing an interaction site for BP180 (as discussed above), but also by affecting the capacity of $\beta 4$ to bind to BP180. What are the mechanisms by which HD1/plectin might regulate the binding of $\beta 4$ with BP180? The results of the two-hybrid assay suggest the possibility of an intramolecular interaction in the $\beta 4$ cytoplasmic domain, since a segment of 85 COOH-terminal residues can bind directly to a more NH₂-terminally located region. Strikingly, this region encompasses the sequences essential for the recruitment of HD1/plectin; i.e., the first pair of FNIII repeats and part of the CS (this study; Niessen et al., 1997a). Hence, it is possible that the intramolecular interaction is disrupted by a high-affinity interaction of HD1/plectin with $\beta 4$ and that binding of BP180 to $\beta 4$ is thus facilitated. Alternatively, the intramolecular interaction between the NH₂ and COOH regions of the $\beta 4$ cytoplasmic domain is regulated by phosphorylation. Binding of HD1/plectin may then help to maintain an unfolded structure of the $\beta 4$ molecule, thereby rendering the binding site for BP180 accessible for interaction. Strong phosphorylation of the COOH-terminal segment of $\beta 4$ has indeed been found in various epithelial cell lines (Falcioni et al., 1989; Kennel et al., 1989). Tyrosine phosphorylation of the TAM (Mainiero et al., 1995, 1996) may play only a secondary role in this process as mutation of the tyrosine residues in this motif had only a minor effect on the localization of BP180 (this study; Borradori et al., 1997).

In conclusion, the results of our study indicate that immortalized PA-JEB keratinocytes lacking $\beta 4$ expression are not capable of forming organized HD-like structures. Transfection of these cells with $\beta 4$ cDNA resulted in restored synthesis of this protein, which was correctly associated with $\alpha 6$ and induced the recruitment of various hemidesmosomal components to the basal side of the cell into junctional complexes typical for HD-like structures. Mutation of the TAM within the $\beta 4$ cytoplasmic domain did not prevent the assembly of these structures. Distinct domains within the cytoplasmic tail of $\beta 4$ were shown to regulate the localization of HD1/plectin and both BP180

and BP230 into HDs. A direct interaction between the cytoplasmic domains of $\beta 4$ and BP180 is involved in this process. The observed interaction of the 85 COOH-terminal residues with a more NH₂-terminally located region suggests that the cytoplasmic domain of $\beta 4$ can undergo an intramolecular interaction. Finally, we propose that the localization of BP180 may be regulated by the complex formation of $\beta 4$ and HD1/plectin that changes the $\beta 4$ conformation such that it can directly interact with BP180.

We thank L. Oomen for excellent assistance with the confocal laser microscope and assembly of the figures, N. Ong for photographic work, and J. Calafat and H. Janssen (all four from The Netherlands Cancer Institute, Amsterdam, The Netherlands) for electron microscopy. We are grateful to M. Jonkman (Groningen University Hospital, Groningen, The Netherlands) for diagnosing the PA-JEB patient and providing us with skin from this patient. We thank P.M. Howley (Harvard University School of Medicine, Boston, MA) for providing the p1432 plasmid and E.M.H. van der Raay-Helmer (Free University of Amsterdam, Amsterdam, The Netherlands) for help with immortalizing the keratinocytes from the primary culture. We acknowledge A.M. Martínez de Velasco for generation of the mouse anti- $\beta 4$ mAb 113C. We thank L. Bruckner-Tuderman, C.H. Damsky, C.G. Figdor, M.A. Glukhova, S.J. Kennel, K. Owaribe, and J.R. Stanley for their generous gifts of antibodies, and F.G. Giancotti for the TAM-mutated $\beta 4$ construct. The authors would like to thank P. James for providing yeast strain PJ69-4A and advice. We acknowledge E. Roos, C.P. Engelfriet, and L. Fontao (all three from The Netherlands Cancer Institute except Engelfriet from Central Laboratory of the Netherlands Red Cross Blood Transfusion Service, Amsterdam, The Netherlands) for critical reading of the manuscript.

This work was supported by grants from the Dutch Cancer Society (NKI 96-1305 and NKI 95-979), the Biomedical and Health Program (BIOMED, BMH4-CT97-2062), and the Dystrophic Epidermolysis Bullosa Research Association (DEBRA Foundation, Crowthorne, UK). L. Borradori was supported by the Roche Foundation (Basel, Switzerland) and a grant from the Swiss National Foundation of Scientific Research (32-51083.97).

Received for publication 30 March 1998 and in revised form 27 May 1998.

Note Added in Proof. Two recent publications have appeared in which a direct interaction between $\beta 4$ and plectin (Reznicek, G.A., J.M. de Pereda, S. Reipert, and G. Wiche. 1998. *J. Cell Biol.* 141:209–225) and between $\beta 4$ and BP180 (Aho, S., and J. Uitto. *Biochem. Biophys. Res. Commun.* 243:694–699) has been demonstrated.

References

- Andrä, K., H. Lassmann, R. Bittner, S. Shorny, R. Fässler, F. Propst, and G. Wiche. 1997. Targeted inactivation of plectin reveals essential function in maintaining the integrity of skin, muscle, and heart cytoarchitecture. *Genes Dev.* 11:3143–3156.
- Baker, S.E., O. Skalli, R.D. Goldman, and J.C.R. Jones. 1997. Laminin-5 and modulation of keratin cytoskeleton arrangement in FG pancreatic carcinoma cells: involvement of IFAP300/HD1 and evidence that laminin-5/cell interactions correlate with a dephosphorylation of $\alpha 6$ A integrin. *Cell Motil. Cytoskeleton.* 36:271–286.
- Borradori, L., and A. Sonnenberg. 1996. Hemidesmosomes: roles in adhesion, signaling and human diseases. *Curr. Opin. Cell Biol.* 8:647–656.
- Borradori, L., P.J. Koch, C.M. Niessen, S. Erkeland, M.R. van Leusden, and A. Sonnenberg. 1997. The localization of bullous pemphigoid antigen 180 (BP180) in hemidesmosomes is mediated by its cytoplasmic domain and seems to be regulated by the $\beta 4$ integrin subunit. *J. Cell Biol.* 136:1333–1347.
- Borradori, L., S. Chavanas, R.Q.J. Schaapveld, L. Gagnoux-Palacios, J. Calafat, G. Meneguzzi, and A. Sonnenberg. 1998. Role of the bullous pemphigoid antigen 180 (BP180) in the assembly of hemidesmosomes and cell adhesion. Reexpression of BP180 in generalized atrophic benign epidermolysis bullosa keratinocytes. *Exp. Cell Res.* 239:463–476.
- Bretscher, A., D. Reczek, and M. Berryman. 1997. Ezrin: a protein requiring conformational activation to link microfilaments to the plasma membrane in the assembly of cell surface structures. *J. Cell Sci.* 110:3011–3018.
- Brown, T.A., S.G. Gil, V.P. Sybert, G.G. Lestringant, G. Tadini, R. Caputo, and W.G. Carter. 1996. Defective integrin $\alpha 6\beta 4$ expression in the skin of pa-

- tients with junctional epidermolysis bullosa and pyloric atresia. *J. Invest. Dermatol.* 107:385–391.
- Burgeson, R.E., and A.M. Christiano. 1997. The dermal-epidermal junction. *Curr. Opin. Cell Biol.* 9:651–658.
- Carter, W.G., P. Kaur, S.G. Gil, P.J. Gahr, and E.A. Wayner. 1990. Distinct functions for integrins $\alpha\beta 1$ in focal adhesions and $\alpha 6\beta 4$ /bullous pemphigoid antigen in a new stable anchoring contact (SAC) of keratinocytes: relation to hemidesmosomes. *J. Cell Biol.* 111:3141–3154.
- Carter, W.G., M.C. Ryan, and P.J. Gahr. 1991. Epiligrin, a new cell adhesion ligand for $\alpha\beta 1$ in epithelial basement membranes. *Cell.* 65:599–610.
- Cullen, B.R. 1987. Use of eukaryotic expression technology in the functional analysis of cloned genes. *Methods Enzymol.* 152:684–703.
- Delwel, G.O., A.A. de Melker, F. Hogervorst, L. Jaspars, D.L.A. Fles, I. Kuikman, A. Lindblom, M. Paulsson, R. Timpl, and A. Sonnenberg. 1994. Distinct and overlapping ligand specificities of the $\alpha 3\beta 1$ and $\alpha 6\beta 1$ integrins: recognition of laminin isoforms. *Mol. Biol. Cell.* 5:203–215.
- Dowling, J., Q.-C. Yu, and E. Fuchs. 1996. $\beta 4$ integrin is required for hemidesmosome formation, cell adhesion, and cell survival. *J. Cell Biol.* 134:559–572.
- Durfee, T., K. Becherer, P.L. Chen, S.H. Yeh, Y. Yang, A.E. Kilburn, W.H. Lee, and S.J. Elledge. 1993. The retinoblastoma protein associates with the protein phosphatase type 1 catalytic subunit. *Genes Dev.* 7:555–569.
- Falcioni, R., N. Perrotti, G. Piaggio, S.K. Kennel, and A. Sacchi. 1989. Insulin-induced phosphorylation of the $\beta 4$ integrin subunit expressed on murine metastatic carcinoma cells. *Mol. Carcinogen.* 2:361–368.
- Fields, S., and O. Song. 1989. A novel system to detect protein-protein interactions. *Nature.* 340:245–247.
- Foisner, R., F.E. Leichtfried, H. Herrmann, J.V. Small, D. Lawson, and G. Wiche. 1988. Cytoskeleton-associated plectin: in situ localization, in vitro reconstitution, and binding to immobilized intermediate filament proteins. *J. Cell Biol.* 106:723–733.
- Gache, Y.S., S. Chavanas, J.P. Lacour, G. Wiche, K. Owaribe, G. Meneguzzi, and J.P. Ortonne. 1996. Defective expression in plectin/HD1 in epidermolysis bullosa simplex with muscular dystrophy. *J. Clin. Invest.* 97:2289–2298.
- Gagnoux-Palacios, L., Y. Gache, J.P. Ortonne, and G. Meneguzzi. 1997. Hemidesmosome assembly assessed by expression of a wild-type integrin $\beta 4$ cDNA in junctional epidermolysis bullosa keratinocytes. *Lab. Invest.* 77:459–468.
- Georges-Labouesse, E., N. Messaddeq, G. Yehia, L. Cadalbert, A. Dierich, and M. LeMeur. 1996. Absence of the $\alpha 6$ integrin leads to epidermolysis bullosa and neonatal death in mice. *Nature Gen.* 13:370–373.
- Giancotti, F.G. 1996. Signal transduction by the $\alpha 6\beta 4$ integrin: charting the path between laminin binding and nuclear events. *J. Cell. Sci.* 109:1165–1172.
- Gietz, R.D., R.H. Schiestl, A.R. Willems, and R.A. Woods. 1995. Studies on the transformation of intact yeast cells by the LiAc/SS-DNA/PEG procedure. *Yeast.* 11:355–360.
- Gilmore, A.P., and K. Burridge. 1996. Regulation of vinculin binding to talin and actin by phosphatidylinositol-4-5-bisphosphate. *Nature.* 381:531–535.
- Giudice, G.J., D.J. Emery, and L.A. Diaz. 1992. Cloning and primary structural analysis of the bullous pemphigoid autoantigen BP180. *J. Invest. Dermatol.* 99:243–250.
- Glukhova, M.A., M.G. Frid, and V.E. Kotliansky. 1990. Developmental changes in expression of contractile and cytoskeletal proteins in human aortic smooth muscle. *J. Biol. Chem.* 265:13042–13046.
- Green, K.J., and J.C.R. Jones. 1996. Desmosomes and hemidesmosomes: structure and function of molecular components. *FASEB (Fed. Am. Soc. Exp. Biol.) J.* 10:871–881.
- Guo, L., L. Degenstein, J. Dowling, Q.-C. Yu, R. Wollman, R. Perman, and E. Fuchs. 1995. Gene targeting of BPAG1: abnormalities in mechanical strength and cell migration in stratified epithelia and neurologic degeneration. *Cell.* 81:233–243.
- Harper, J.W., G. Adami, N. Wei, K. Keyomarsi, and S.J. Elledge. 1993. The p21 Cdk-interacting protein Cip1 is a potent inhibitor of G1 cyclin-dependent kinases. *Cell.* 75:805–816.
- Herrmann, H., and G. Wiche. 1987. Plectin and IFAP-300K are homologous proteins binding to microtubule-associated proteins 1 and 2 and to the 240-kilodalton subunit of spectrin. *J. Biol. Chem.* 262:1320–1325.
- Hessle, H., L.Y. Sakai, D.W. Hollister, and E. Engvall. 1984. Basement membrane diversity detected by monoclonal antibodies. *Differentiation.* 26:49–54.
- Hieda, Y., Y. Nishizawa, J. Uematsu, and K. Owaribe. 1992. Identification of a new hemidesmosomal protein, HD1: a major, high molecular mass component of isolated hemidesmosomes. *J. Cell Biol.* 116:1497–1506.
- Hogervorst, F., I. Kuikman, A.E.G. Kr. von dem Borne, and A. Sonnenberg. 1990. Cloning and sequence analysis of $\beta 4$ cDNA: an integrin subunit that contains a unique 118 kD cytoplasmic domain. *EMBO (Eur. Mol. Biol. Organ.) J.* 9:765–770.
- Hogervorst, F., L.G. Admiraal, C.M. Niessen, I. Kuikman, H. Daams, H. Janssen, and A. Sonnenberg. 1993. Biochemical characterization and tissue distribution of the A and B variants of the integrin $\alpha 6$ subunit. *J. Cell Biol.* 121:179–191.
- Hopkinson, S.B., K.S. Riddelle, and J.C.R. Jones. 1992. Cytoplasmic domain of the 180-kD bullous pemphigoid antigen, a hemidesmosomal component: molecular and cell biologic characterization. *J. Invest. Dermatol.* 99:264–270.
- Hopkinson, S.B., S.E. Baker, and J.C.R. Jones. 1995. Molecular genetic studies of a human epidermal autoantigen (the 180-kD bullous pemphigoid antigen/BP180): identification of functionally important sequences within the BP180 molecule and evidence for an interaction between BP180 and $\alpha 6$ integrin. *J. Cell Biol.* 130:117–125.
- Iwabuchi, K., B. Li, P. Bartel, and S. Fields. 1993. Use of the two-hybrid system to identify the domain of p53 involved in oligomerization. *Oncogene.* 8:1693–1696.
- James, P., J. Halladay, and E.A. Craig. 1996. Genomic libraries and a host strain designed for highly efficient two-hybrid selection in yeast. *Genetics.* 144:1425–1436.
- Johnson, R.P., and S.W. Craig. 1995. F-actin binding site masked by the intramolecular association of vinculin head and tail domains. *Nature.* 373:261–264.
- Jonkman, M.F., M.C.J.M. de Jong, K. Heeres, H.H. Pas, J.B. van der Meer, K. Owaribe, A.M. Martínez de Velasco, C.M. Niessen, and A. Sonnenberg. 1995. 180-kD bullous pemphigoid antigen (BP180) is deficient in generalized atrophic benign epidermolysis bullosa. *J. Clin. Invest.* 95:1345–1352.
- Kantor, R.R.S., M.J. Mattes, K.O. Lloyd, L.J. Old, and A.P. Albino. 1987. Biochemical analysis of two cell surface glycoprotein complexes, very common antigen 1 and very common antigen 2. *J. Biol. Chem.* 262:15158–15165.
- Keizer, G.D., A.A. te Velde, R. Schwarting, C.G. Figdor, and J.E. de Vries. 1987. Role of p150,95 in adhesion, migration, chemotaxis and phagocytosis of human monocytes. *Eur. J. Immunol.* 17:1317–1322.
- Kennel, S.J., L.J. Foote, R. Falcioni, A. Sonnenberg, C.D. Stringer, C. Crouse, and M.E. Hemler. 1989. Analysis of the tumor-associated antigen TSP-180. Identity with the $\alpha 6\beta 4$ in the integrin superfamily. *J. Biol. Chem.* 264:15515–15521.
- Kennel, S.J., R.G. Epler, T.K. Lankford, L.J. Foote, V. Dickas, M. Canamucio, R. Cavaliere, M. Cosimelli, I. Ventura, R. Falcioni, and A. Sacchi. 1990. Second generation monoclonal antibodies to the human integrin $\alpha 6\beta 4$. *Hybridoma.* 9:243–255.
- Kurpakus, M.A., and J.C.R. Jones. 1991. A novel hemidesmosomal plaque component: tissue distribution and incorporation into assembling hemidesmosomes in an in vitro model. *Exp. Cell Res.* 194:139–146.
- Li, B., and S. Fields. 1993. Identification of mutations in p53 that affect its binding to SV40 T antigen by using the yeast two-hybrid system. *FASEB (Fed. Am. Soc. Exp. Biol.) J.* 7:957–963.
- Li, K., K. Tamai, E.M.L. Tan, and J. Uitto. 1993. Cloning of type XVII collagen. Complementary and genomic DNA sequences of mouse 180-kilodalton bullous pemphigoid antigen (BPAG2) predict an interrupted collagenous domain, a transmembrane segment, and unusual features in the 5'-end of the gene and the 3'-untranslated region of the mRNA. *J. Biol. Chem.* 268:8825–8834.
- Mainiero, F., A. Pepe, K.K. Wary, L. Spinardi, M. Mohammadi, J. Schlessinger, and F.G. Giancotti. 1995. Signal transduction by the $\alpha 6\beta 4$ integrin: distinct $\beta 4$ subunit sites mediate recruitment of Shc/Grb2 and association with the cytoskeleton of hemidesmosomes. *EMBO (Eur. Mol. Biol. Organ.) J.* 14:4470–4481.
- Marchisio, P.C., S. Bondanza, O. Cremona, R. Cancedda, and M. De Luca. 1991. Polarized expression of integrin receptors ($\alpha 6\beta 4$, $\alpha 2\beta 1$, $\alpha 3\beta 1$, and $\alpha v\beta 5$) and their relationship with the cytoskeletal and basement membrane matrix in cultured human keratinocytes. *J. Cell Biol.* 112:761–773.
- Marchisio, P.C., O. Cremona, P. Savoia, G. Pellegrin, J.P. Ortonne, P. Verardo, R.E. Burgeson, R. Cancedda, and M. De Luca. 1993. The basement membrane protein BM-600/nicein codistributes with kalinin and the $\alpha 6\beta 4$ integrin in human cultured keratinocytes. *Exp. Cell Res.* 205:205–211.
- McGrath, J.A., B. Gatalica, A.M. Christiano, K. Li, K. Owaribe, J.R. McMillan, R.A. Eady, and J. Uitto. 1995. Mutations in the 180-kD bullous pemphigoid antigen (BPAG2), a hemidesmosomal transmembrane collagen (COL17A1), in generalized atrophic benign epidermolysis bullosa. *Nature Genet.* 11:83–86.
- McLean, W.H.I., L. Pulkkinen, F.J.D. Smith, E.L. Rugg, E.B. Lane, F. Bullrich, R.E. Burgeson, S. Amano, D.L. Hudson, K. Owaribe, J.A. McGrath, J.R. McMillan, R.A.J. Eady, I.M. Leigh, A.M. Christiano, and J. Uitto. 1996. Loss of plectin causes epidermolysis bullosa with muscular dystrophy: cDNA cloning and genomic organization. *Genes Dev.* 10:1724–1735.
- Münger, K., W.C. Phelps, V. Bubb, P.M. Howley, and R. Schlegel. 1989. The E6 and E7 genes of the human papillomavirus type 16 together are necessary and sufficient for transformation of primary human keratinocytes. *J. Virol.* 63:4417–4421.
- Niessen, C.M., F. Hogervorst, L.H. Jaspars, A.A. de Melker, G.O. Delwel, E.H.M. Hulsman, I. Kuikman, and A. Sonnenberg. 1994. The $\alpha 6\beta 4$ integrin is a receptor for both laminin and kalinin. *Exp. Cell Res.* 211:360–367.
- Niessen, C.M., L.M.H. van der Raaij-Helmer, E.H.M. Hulsman, R. van der Neut, M.F. Jonkman, and A. Sonnenberg. 1996. Deficiency of the integrin $\beta 4$ subunit in junctional epidermolysis bullosa with pyloric atresia: consequences for hemidesmosome formation and adhesion properties. *J. Cell Sci.* 109:1695–1706.
- Niessen, C.M., E.H.M. Hulsman, L.C.J.M. Oomen, I. Kuikman, and A. Sonnenberg. 1997a. A minimal region on the integrin $\beta 4$ subunit that is critical to its localization in hemidesmosomes regulates the distribution of HD1/plectin in COS-7 cells. *J. Cell Sci.* 110:1705–1716.
- Niessen, C.M., E.H.M. Hulsman, E.S. Rots, P. Sánchez-Aparicio, and A. Sonnenberg. 1997b. Integrin $\alpha 6\beta 4$ forms a complex with the cytoskeletal protein HD1 and induces its redistribution in transfected COS-7 cells. *Mol. Biol. Cell.* 8:555–566.
- Nievers, M.G., R.Q.J. Schaapveld, L.C.J.M. Oomen, L. Fontao, D. Geerts, and A. Sonnenberg. 1998. Ligand-independent role of the $\beta 4$ integrin subunit in the formation of hemidesmosomes. *J. Cell Sci.* 111:1659–1672.
- Nishizawa, Y., J. Uematsu, and K. Owaribe. 1993. HD4, a 180 kDa bullous pemphigoid antigen, is a major transmembrane glycoprotein of the hemidesmosome. *J. Biochem. (Tokyo).* 113:493–501.
- Pulkkinen, L., V.E. Kimonis, Y. Xu, E.N. Spanou, W.H.I. McLean, and J.

- Uitto. 1997. Homozygous $\alpha 6$ integrin mutation in junctional epidermolysis bullosa with congenital duodenal atresia. *Hum. Mol. Genet.* 6:669–674.
- Rousselle, P., G.P. Lundstrum, D.R. Keene, and R.E. Burgeson. 1991. Kalinin: an epithelium-specific basement membrane adhesion molecule that is a component of anchoring filaments. *J. Cell Biol.* 114:567–576.
- Rousselle, P., and M. Aumailley. 1994. Kalinin is more efficient than laminin in promoting adhesion of primary keratinocytes and some other epithelial cells and has a different requirement for integrin receptors. *J. Cell Biol.* 125:205–214.
- Ruzzi, L., L. Gagnoux-Palacios, M. Pinola, S. Belli, G. Meneguzzi, M. D'Alessio, and G. Zambruno. 1997. A homozygous mutation in the integrin $\alpha 6$ gene in junctional epidermolysis bullosa with pyloric atresia. *J. Clin. Invest.* 99:2826–2831.
- Sánchez-Aparicio, P., A.M. Martínez de Velasco, C.M. Niessen, L. Borradori, I. Kuikman, E.H.M. Hulsman, R. Fässler, K. Owaribe, and A. Sonnenberg. 1997. The subcellular distribution of the high molecular mass protein, HD1, is determined by the cytoplasmic domain of the integrin $\beta 4$ subunit. *J. Cell Sci.* 110:169–178.
- Sawamura, D., K. Li, M.L. Chu, and J. Uitto. 1991. Human bullous pemphigoid antigen (BPAG1). Amino acid sequences deduced from cloned cDNAs predict biologically important peptide segments and protein domains. *J. Biol. Chem.* 266:17784–17790.
- Skalli, O., J.C.R. Jones, R. Gagescu, and R.D. Goldman. 1994. IFAP 300 is common to desmosomes and hemidesmosomes and is a possible linker of intermediate filaments to these junctions. *J. Cell Biol.* 125:159–170.
- Smith, F.J.D., R.A.J. Eady, I.M. Leigh, J.R. McMillan, E.L. Rugg, D.P. Kelsell, S.P. Bryant, N.K. Spurr, J.F. Geddes, G. Kirtschig, G. Milana, A.G. de Bono, K. Owaribe, G. Wiche, L. Pulkkinen, J. Uitto, W.H.I. McLean, and E.B. Lane. 1996. Plectin deficiency results in muscular dystrophy with epidermolysis bullosa. *Nature Genet.* 13:450–457.
- Sonnenberg, A., H. Daams, J. Calafat, and J. Hilgers. 1986. In vitro differentiation and progression of mouse mammary tumor cells. *Cancer Res.* 46:5913–5922.
- Sonnenberg, A., H. Janssen, F. Hogervorst, J. Calafat, and J. Hilgers. 1987. A complex of platelet glycoproteins Ic and IIa identified by a rat monoclonal antibody. *J. Biol. Chem.* 262:10376–10383.
- Sonnenberg, A., A.A. de Melker, A.M. Martínez de Velasco, H. Janssen, J. Calafat, and C.M. Niessen. 1993. Formation of hemidesmosomes in cells of a transformed murine mammary tumor cell line and mechanisms involved in adherence of these cells to laminin and kalinin. *J. Cell Sci.* 106:1083–1102.
- Spinardi, L., Y.-L. Ren, R. Sanders, and F.G. Giancotti. 1993. The $\beta 4$ subunit cytoplasmic domain mediates the interaction of $\alpha 6\beta 4$ integrin with the cytoskeleton of hemidesmosomes. *Mol. Biol. Cell.* 4:871–884.
- Spinardi, L., S. Einheber, T. Cullen, T.A. Milner, and F.G. Giancotti. 1995. A recombinant tail-less integrin $\beta 4$ subunit disrupts hemidesmosomes, but does not suppress $\alpha 6\beta 4$ -mediated cell adhesion to laminins. *J. Cell Biol.* 129:473–487.
- Stahelin, L.A. 1974. Structure and function of intercellular junctions. *Int. Rev. Cytol.* 39:191–278.
- Stanley, J.R., T. Tanaka, S. Mueller, V. Klaus-Kovtun, and D. Roop. 1988. Isolation of cDNA for bullous pemphigoid antigen by use of patients' autoantibodies. *J. Clin. Invest.* 82:1864–1870.
- Steenbergen, R.D.M., J.M.M. Walboomers, C.J.L.M. Meijer, E.M.H. van der Raaij-Helmer, J.N. Parker, L.T. Chow, T.R. Broker, and P.J.F. Snijders. 1996. Transition of human papillomavirus type 16 and 18 transfected human foreskin keratinocytes towards immortality: activation of telomerase and allele losses at 3p, 10p, 11q and/or 18q. *Oncogene.* 13:1249–1257.
- Suzuki, S., and Y. Naitoh. 1990. Amino acid sequence of a novel integrin $\beta 4$ subunit and primary expression of the mRNA in epithelial cells. *EMBO (Eur. Mol. Biol. Organ.) J.* 9:757–763.
- Tamura, R., C. Rozzo, L. Starr, J. Chambers, L.F. Reichardt, H.M. Cooper, and V. Quaranta. 1990. Epithelial integrin $\alpha 6\beta 4$: complete primary structure of $\alpha 6$ and variant forms of $\beta 4$. *J. Cell Biol.* 111:1593–1604.
- Tanaka, T., N.J. Korman, H. Shimizu, R.A.J. Eady, V. Klaus-Kovtun, K. Cehrs, and J.R. Stanley. 1990. Production of rabbit antibodies against carboxy-terminal epitopes encoded by bullous pemphigoid cDNA. *J. Invest. Dermatol.* 94:617–623.
- Van der Neut, R., P. Krimpenfort, J. Calafat, C.M. Niessen, and A. Sonnenberg. 1996. Epithelial detachment due to absence of hemidesmosomes in integrin $\beta 4$ null mice. *Nature Genet.* 13:366–369.
- Vidal, F., D. Aberdam, C. Miquel, A.M. Christiano, L. Pulkkinen, J. Uitto, J.P. Ortonne, and G. Meneguzzi. 1995. Integrin $\beta 4$ mutations associated with junctional epidermolysis bullosa with pyloric atresia. *Nature Genet.* 10:229–234.
- Von dem Borne, A.E.G. Kr., P.W. Modderman, L.G. Admiraal, H.K. Nieuwenhuis. 1989. In Leukocyte Typing IV. W. Knapp, B. Dörken, W.R. Gilks, E.P. Rieber, R.E. Schmidt, H. Stein, and A.E.G. Kr. von dem Borne, editors. Oxford University Press, New York. 951 pp.
- Wayner, E.A., and W.G. Carter. 1987. Identification of multiple cell adhesion receptors for collagen and fibronectin in human fibrosarcoma cell possessing unique α and common β subunits. *J. Cell Biol.* 105:1873–1884.
- Werb, Z., P.M. Tremble, O. Behrendtsen, E. Crowley, and C.H. Damsky. 1989. Signal transduction through the fibronectin receptor induces collagenase and stromelysin gene expression. *J. Cell Biol.* 109:877–889.
- Wiche, G., B. Becker, K. Luber, G. Weitzer, M.J. Castanon, R. Hauptmann, C. Stratowa, and M. Stewart. 1991. Cloning and sequencing of rat plectin indicates a 466-kD polypeptide chain with a three domain structure based on a central α -helical coiled-coil. *J. Cell Biol.* 114:83–99.
- Yang, H.-Y., N. Lieska, A.E. Goldman, and R.D. Goldman. 1985. A 300,000 mol-wt intermediate filament-associated protein in baby hamster kidney (BHK-21) cells. *J. Cell Biol.* 100:620–631.
- Yang, Y.M., J. Dowling, Q.C. Yu, P. Kouklis, D.W. Cleveland, and E. Fuchs. 1996. An essential cytoskeletal linker protein connecting actin microfilaments to intermediate filaments. *Cell.* 86:655–665.