

# Role of Fibronectin in the Migration of Fibroblasts into Plasma Clots

Peter Knox, Sheila Crooks, and Caroline S. Rimmer

Department of Biochemistry, St. George's Hospital Medical School, London SW17 0RE, England

**Abstract.** The adhesion and migration of human diploid fibroblasts on plasma clots were measured. The role of plasma fibronectin was examined by depleting plasma of fibronectin before clotting. Fibronectin was not essential for cell adhesion and spreading, although rates were slightly slower on depleted clots. Rates of migration on the surface of clots were unaffected by fibronectin depletion.

In contrast, fibronectin was an absolute requirement

for migration of cells into plasma clots. Cells migrated rapidly into control clots but completely failed to penetrate the surface of fibronectin-depleted clots. The effect of depletion could only be reversed by adding fibronectin to depleted plasma before clotting. Adsorption of fibronectin after clotting failed to reverse the effect of depletion, suggesting that fibronectin had to be cross-linked by transglutaminase during the clotting process.

**T**HE factors involved in fibroblast adhesion and migration have been extensively studied. Most studies have made use of artificial substrates; these need to have a suitably charged surface (5, 19). In the presence of serum, fibroblasts adhere to such surfaces and spread into a characteristic bipolar morphology (34). This adhesion and spreading is a prerequisite for the proliferation of normal cells (31).

Two plasma proteins can promote cell adhesion. One is fibronectin, a 450,000-D dimeric protein; the structure and mechanism of action of this protein are well documented (12). The other adhesive protein in plasma is 70,000 D (2, 10, 16, 17, 30) and is unrelated to fibronectin. Less is presently known about this protein but it appears to have a different mechanism of action from fibronectin (17).

During the wound response, fibroblasts and other cell types interact with the fibrin lattice of the clot that forms at the site of tissue damage. Fibroblasts migrate into certain areas of the clot, proliferate, and synthesize collagen and other components of the connective tissue extracellular matrix. The adhesion of cells to adsorbed monomolecular layers of fibrin has been studied (9, 23, 24), and fibronectin has been shown to increase rates of attachment and spreading (9). In the clot that forms physiologically, the fibrin is in the form of a three-dimensional lattice. The fibrin is cross-linked by transglutaminase, the factor XIII of the clotting cascade which is also known to cross-link plasma fibronectin to fibrin (20, 21).

In this study we have examined the behavior of human diploid fibroblasts on plasma clots and in particular the role of fibronectin in the adhesion and subsequent migration into clots.

## Materials and Methods

### Preparation of Plasma Clots

Blood was collected from volunteers and anticoagulated with EDTA (final concentration 3.5 mM). After centrifugation at 5,000 g for 10 min, plasma was

aspirated and dialyzed at 4°C against phosphate-buffered saline (PBS). Assays of adhesion, spreading, and migration on the surface of plasma clots were done using 35-mm petri dishes. To 1 ml of plasma kept on ice was added 10  $\mu$ l of 150 mM CaCl<sub>2</sub> and 10  $\mu$ l of 50 IU/ml thrombin. The mixture was rapidly mixed and added to a petri dish which was placed in a 37°C incubator for 15 min to allow clotting to take place. In some experiments, 24-well dishes were used. In this case, 0.5-ml clots were formed in each well.

### Depletion of Fibronectin

10-ml bed vol of gelatin-Ultrodex (LKB, Selsdon, Surrey) was used. 5-ml samples of plasma were passed through each column before regeneration. Plasma was eluted with PBS, and protein-containing fractions were pooled and concentrated back to starting volume using Amicon C25 Centriflo cones (Amicon Corp., Danvers, MA). Depleted plasma was dialyzed at 4°C against PBS. Before recalcification and clotting, the protein concentration was measured spectrophotometrically at 280 nm. The depleted plasma was adjusted by further concentration or dilution to give the same protein concentration as control plasma. Clotting of fibronectin-depleted plasma was achieved in the same way as control plasma. Purified human fibronectin was obtained from LKB and was, unless stated otherwise, added back to plasma at 0.3 mg/ml of plasma before or after clotting as indicated.

### Cells

BCL-D1 human diploid fibroblasts were obtained from Gibco (Uxbridge, Middlesex, UK) and cultured routinely in Ham's F10 medium (Gibco) supplemented with 10% fetal bovine serum (Gibco).

### Cell Attachment Assay

Confluent monolayers of BCL-D1 cells were trypsinized, suspended in serumless F10 medium, and adjusted to a density of  $5 \times 10^4$ /ml. 1-ml aliquots of the cell suspension were added to plasma clots in petri dishes and 0.5-ml aliquots to those in multiwells. At time intervals medium was removed and each clot washed twice with 1 ml of F10 to remove non-adherent cells. The initial medium and two washes were combined and cell number determined with a hemocytometer.

### Cell Spreading Assay

A drawing-tube attached to an inverted microscope was used to focus the image onto a Hi-Pad digitizer tablet (Bausch & Lomb Inc., Rochester, NY) interfaced to an Apple II plus microcomputer (Apple Computer Inc., Cupertino, CA). The periphery of cells were logged via the digitizer, and specifically tailored programs were used to compute the longest axis as previously described (15).

### Cell Migration on Plasma Clots

Before the addition of cell suspensions to plasma clots, 5-mm lengths of 30-swg stainless steel wire were bent into right angles and embedded in the surface of clots. 24 h after adding cell suspensions and at four 0.5-h intervals thereafter, photomicrographs were taken of the area between the arms of the wire right angle.

Enlargements of the micrographs were prepared and tracings then used to plot the migration of each cell in the field at half-hour intervals; the wire right-angles were used to orientate tracing overlays. The digitizer and computer were then used to measure the distance migrated per unit time. BCL-D1 cells are very bipolar and so the distance measured was the difference between the leading point of the cell at each time point.

### Cell Migration into Plasma Clots

Migration chambers were made from two microscope slides separated by shaped 1.5-mm thick spacers. Microscope slides had previously been treated with Siliclad (Becton Dickinson) to ensure that the chamber had non-adherent surfaces. Calcium and thrombin were added to plasma samples and the mixture introduced into the chambers with a syringe and needle to give a depth of 1 cm. The chamber was then incubated at 37°C for 15 min to ensure complete clotting. A suspension of  $2 \times 10^4$  cells/ml was then added onto each clot with a syringe and needle to give a depth of 0.5 cm. The open end of the chamber was sealed with dental wax and the chambers then incubated vertically at 37°C. After 24 h the chambers were placed horizontally on a stage of an inverted microscope and migration into the clot determined with the aid of a graticule by counting the number of cells in 0.2-mm intervals from the clot-medium interface.

### Diffusion of Fibronectin into Plasma Clot

Plasma clots were formed in plastic tubing of internal diameter 0.5 cm and at  $t = 0$ , 10  $\mu$ l of  $^{125}$ I-labeled fibronectin was added to the surface of each clot. After incubation at 37°C for different periods of time, clots were snap-frozen and sliced at 1-mm intervals and each slice counted.

## Results

Plasma clots were prepared from EDTA-plasma after dialysis and recalcification. Clots 1-mm thick were formed in petri dishes and despite their fibrillar nature, an inverted phase-contrast microscope allowed visualization of cells seeded onto the surface of the clots. Fresh blood was used throughout this study since when outdated blood from the local blood bank was used, the clots were visibly less fibrillar and often began to lyse before completion of an experiment.

When suspensions of fibroblasts were seeded in protein-free medium onto plasma clots, cells adhered and spread on the surface of the fibrin lattice. Fig. 1 shows a photomicrograph of BCL-D1 cells 6 h after seeding onto a plasma clot. The fibrillar nature of the clot can be seen. The cells have a more spindle-shaped appearance than the same cells seeded onto tissue culture plastic.

The role of fibronectin in the adhesion and spreading of cells on plasma clots was examined by removing fibronectin from fresh plasma by affinity chromatography before clotting. In addition to control plasma clots and clots prepared from fibronectin-depleted plasma, two further sets of plasma clots were used in the following experiments. Purified fibronectin was added back to depleted plasma in two ways. The first was addition before clotting; this would result in the covalent cross-linking of fibronectin to fibrin by transglutaminase. The second was to clot fibronectin-depleted plasma and then to adsorb fibronectin to the resulting clots; in this case fibronectin would be physically adsorbed to fibrin and little if any



*Figure 1.* Human diploid fibroblasts on plasma clots. This photomicrograph was taken using phase-contrast optics of BCL-D1 cells 6 h after they were added to a control plasma clot.

would be cross-linked to it. Purified thrombin was used in the preparation of clots. While control plasma always clotted rapidly when recalcified, fibronectin-depleted plasma clotted more slowly since surface-activating proteins such as Hageman factor also bind to gelatin-affinity columns.

Fig. 2 shows the rates of attachment of BCL-D1 cells to different plasma clots. Rates of attachment to fibronectin-depleted clots were slower than to control clots; however, by 2 h all cells had adhered to both types of clot. When fibronectin was added back to depleted plasma, then the effect of depletion was reversed and this was true whether it was added before or after clotting. To determine the role of cell surface or secreted fibronectin in the adhesion to fibronectin-depleted clots, a series of studies were done using anti-fibronectin antiserum. In initial experiments a dilution of a polyclonal antiserum was found that inhibited the effect of re-addition of fibronectin. Fig. 3 shows the effect of the antiserum on the adhesion of cells to fibronectin-depleted clots. The antiserum

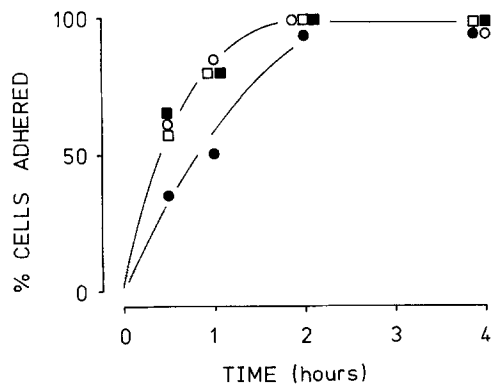

**Figure 2.** Adhesion of BCL-D1 cells to plasma clots. A BCL-D1 cell suspension in serum-less medium was added to control plasma clots (○), fibronectin-depleted plasma clots (●), clots formed from fibronectin-depleted plasma with fibronectin added before clotting (■), or clots formed from fibronectin-depleted plasma with fibronectin adsorbed after clotting (□). Cell adhesion was measured at time intervals. Each point represents the mean of three observations. Maximum variation between observations was 6%.

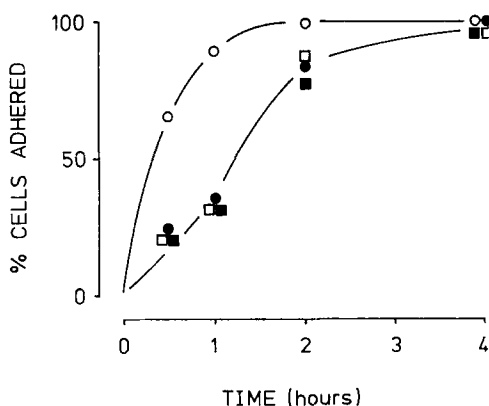

**Figure 3.** The effect of anti-fibronectin antiserum on attachment to plasma clots. Fibronectin-depleted plasma was used to prepare plasma clots with (○, ●) or without (□, ■) the addition of fibronectin. A suspension of BCL-D1 cells in serum-less medium was added to the clots with (●, ■) or without (○, □) the addition of polyclonal antiserum to human fibronectin at a final dilution of 1:20. Cell attachment was monitored as in Fig. 2.

abolishes the effect of re-added fibronectin but has no effect on the ultimate ability of all cells to adhere.

When depleted samples of plasma were subjected to SDS gel electrophoresis followed by electroblotting and detection with anti-fibronectin antiserum, no fibronectin was detectable. To rule out the possibility of traces of fibronectin remaining after affinity chromatography, samples of depleted plasma were rechromatographed using gelatin affinity columns, and polyclonal anti-human plasma fibronectin antibodies were added before clotting. There was no significant difference between the results obtained using this plasma and plasma that had been passed once through excess affinity gel.

Cell spreading was measured morphometrically by focusing the phase-contrast microscope image onto a digitizer tablet interfaced to a microcomputer. Fig. 4 shows that cells spread on fibronectin-depleted plasma clots at slower rates than on control clots. As in the case of attachment this is only a transient difference and with time both sets of clots became indistinguishable. In the case of re-addition of fibronectin there was a clear difference between fibronectin added before and after clotting. Only in the case of addition before clotting was the rate of spreading the same as controls and clots to which fibronectin had been added after clotting behaved essentially like fibronectin-depleted plasma clots.

Two aspects of migration were studied. Migration on the surface of the clot was studied by taking photomicrographs of marked fields at time intervals and using the digitizer to measure rate of locomotion. These measurements were made 1 d after seeding cells onto the surface of the clots and so cells were by this time equally well spread on control and fibronectin-depleted clots. Table I shows that fibronectin depletion had no effect on the rate of migration over the surface of a clot.

To measure migration into clots, chambers were made using silicone-treated glass. The chambers were constructed so that they could be incubated vertically to allow suspended cells to settle onto the surface of the clot. Fig. 5 shows a diagram of the chamber. Cells were added to the surface of

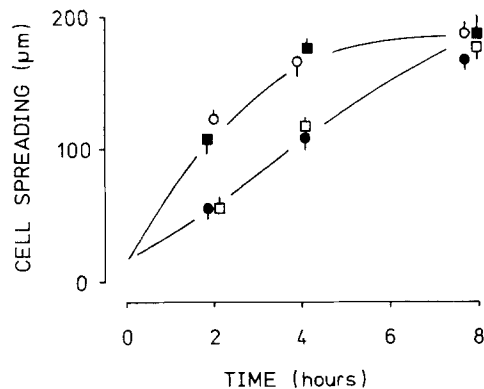

**Figure 4.** The spreading of BCL-D1 cells on plasma clots. A BCL-D1 cell suspension in serum-less medium was added to control plasma clots (○), fibronectin-depleted plasma clots (●), clots formed from fibronectin-depleted plasma with fibronectin added before clotting (■), or clots formed from fibronectin-depleted plasma with fibronectin adsorbed after clotting (□). Cell spreading was measured morphometrically at time intervals. Results represent the mean  $\pm$  one standard deviation of 20 cells on each of triplicate clots (i.e., 60 cells in total).

Table I. Rates of Migration on Plasma Clots

Exp. no.	Migration ( $\mu\text{m}/\text{h}$ )	
	Control plasma clots	Fibronectin-depleted clots
1	$78 \pm 6$	$85 \pm 13$
2	$65 \pm 8$	$72 \pm 8$
3	$85 \pm 12$	$79 \pm 11$
4	$99 \pm 6$	$87 \pm 13$

In four separate experiments plasma clots and fibronectin-depleted clots were prepared from the blood of four different volunteers. Each results represent the mean  $\pm$  SD of 20 cells on duplicate clots measured over four 30-min periods.

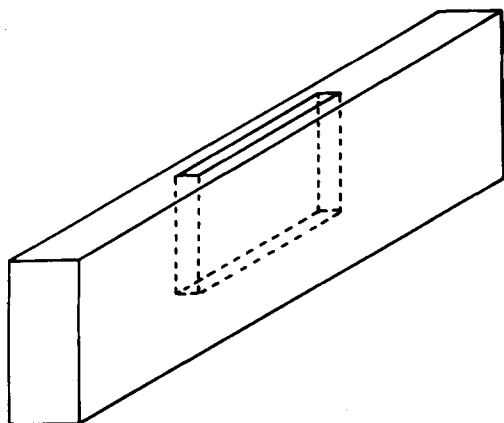

Figure 5. Diagram of the chambers used to study migration into plasma clots.

the clot in serum-less medium and at timed intervals chambers were turned through  $90^\circ$  and placed on a microscope stage to measure migration of cells into the clot. Cells failed to adhere to the siliconized glass used for construction of the chambers and so any migration must have occurred through the fibrin lattice of the clots.

Fig. 6 shows a photomicrograph of BCL-D1 cells migrating within a control plasma clot. Cells have long processes and show non-uniform morphology. The cells that appear spherical in shape are in fact cells spread along the axis of viewing; this is established by focusing at different levels within the clot.

Fig. 7 shows the results of a typical experiment measuring migration into different clots. While fibroblasts moved rapidly into control clots, cells were completely unable to migrate into fibronectin-depleted clots. In chambers containing fibronectin-depleted clots, cells adhered, spread, and migrated over the surface of the clot but failed even after a 3-d incubation to penetrate into the fibrin lattice. Addition of fibronectin before clotting completely reversed the effect of depletion. Adsorption of fibronectin to the plasma clot failed to reverse depletion and again cells failed to enter the fibrin mesh. Even adsorption of fibronectin for 24 h before the addition of cells failed to reverse the effect of depletion, and no cells migrated into the clot. The rates of migration shown in Fig. 7 appear to be less than those in Table I. The reason is that fibroblasts show random migratory patterns and the data in Table I refer to absolute migration, whereas that in Fig. 7 concern net movement.

Since fibronectin binds to fibrin, it was necessary to establish that fibronectin, when added to the surface of a clot, diffused through the fibrin mesh. This was achieved using

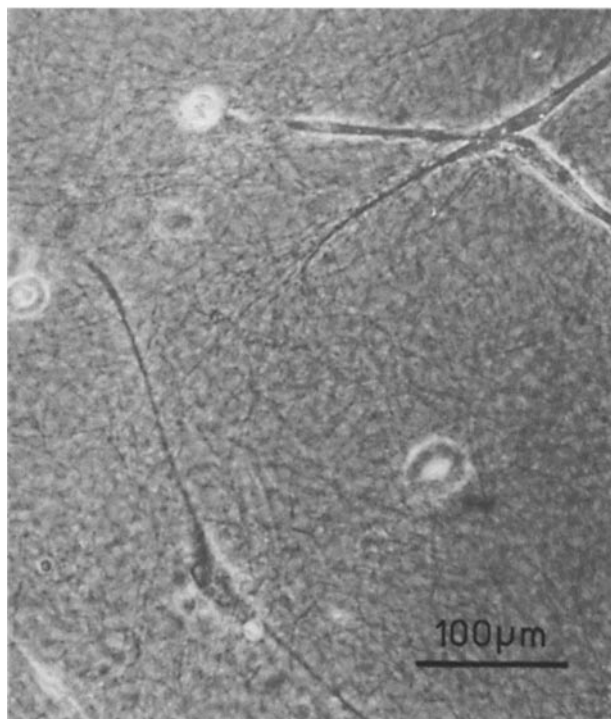

Figure 6. Photomicrograph of cells migrating through a plasma clot. A cell suspension was added to the surface of plasma clots in migration chambers. After incubation at  $37^\circ\text{C}$  for 24 h, a chamber was turned through  $90^\circ$  and placed on the stage of a microscope and photographed with phase-contrast optics.

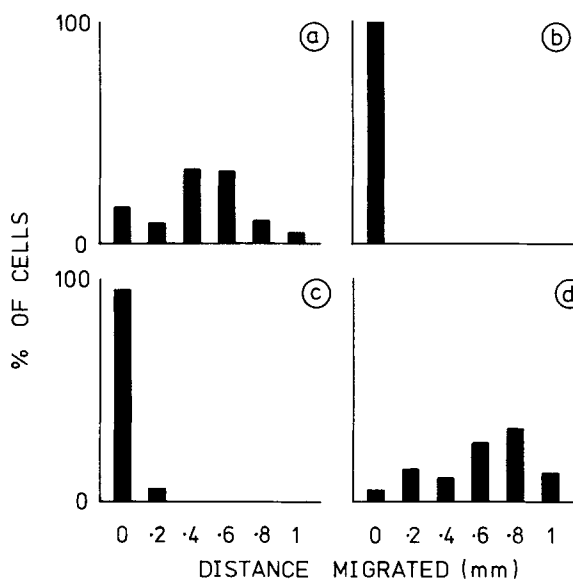
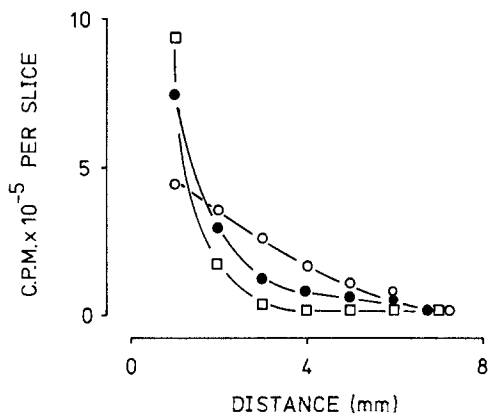

Figure 7. Migration of fibroblasts into plasma clots. Migration chambers were prepared containing (a) control plasma clots, (b) fibronectin-depleted plasma clots, (c) clots formed from fibronectin-depleted plasma with fibronectin adsorbed after clotting, or (d) clots formed from fibronectin-depleted plasma with fibronectin added before clotting. After adding cell suspensions and sealing the open end, the chambers were incubated vertically for 24 h at which time they were turned through  $90^\circ$ , placed on the stage of a microscope, and the number of cells migrating regular distances from the clot/medium interface measured with the aid of a graticule.



**Figure 8.** Diffusion of fibronectin into plasma clots. Replicate plasma clots were formed from fibronectin-depleted plasma. After adding radiolabeled fibronectin to the surface of clots, they were incubated at 37°C. At 4 h (□), 8 h (●), and 24 h (○) clots were snap-frozen, sliced, and counted.

radioiodinated fibronectin which was added to the surface of plasma clots. Fig. 8 shows the extent to which fibronectin had diffused into clots at different time intervals. SDS gel electrophoresis and autoradiography was used to confirm that >98% of label diffusing into the clots was native fibronectin, and autoradiography of slices of clot was used to confirm that fibronectin diffused uniformly throughout the clot.

## Discussion

During a wound response, cells migrate into the coagulum formed at the site of tissue damage. Here it is shown that plasma fibronectin is necessary for the migration of fibroblasts into plasma clots. The role played by fibronectin is complex. Although necessary for migration into clots, it is not necessary for the attachment and spreading of cells on the surface of fibrin since when clots were prepared from fibronectin-depleted plasma, there were only small differences in initial rates of adhesion. Migration over the surface of plasma clots was also unaffected by removal of fibronectin. Antisera to fibronectin did not prevent adhesion to fibronectin-depleted plasma clots, suggesting that the cells can adhere and spread via mechanisms that do not involve plasma or cellular fibronectin, although fibronectin can mediate adhesion to adsorbed monomolecular layers of fibrin (9). Fibronectin is not essential for the adhesion of cells to tissue culture plastic (11, 32) or to collagen (8, 26), and there is in plasma at least one other adhesive glycoprotein known as serum spreading factor (vitronectin) (2, 10, 17, 30), which is unrelated to fibronectin and stimulates adhesion via a different mechanism (15, 18).

The requirement for fibronectin in migration into a clot was absolute. Cells failed, even over extended time courses, to migrate into clots formed from fibronectin-depleted plasma. This effect was reversed by the addition of purified fibronectin before clotting, suggesting that the fibronectin needs to be covalently cross-linked to fibrin by transglutaminase. The importance of this enzyme has been demonstrated *in vitro* (4, 14, 33) where optimal growth on clots requires the presence of the enzyme. Individuals with an inherited deficiency of the enzyme display poor wound-healing (1, 6).

The results using fibronectin added after clotting of depleted

plasma are only valid if the fibronectin has diffused into the matrix of the clot. This was confirmed using radioiodinated fibronectin. The fact that serum contains only slightly less fibronectin than plasma indicates that only a small percentage of the total plasma concentration becomes involved in fibrin formation. Fibronectin diffused rapidly into depleted clots and the diffusion coefficient was calculated as  $0.9 \times 10^{-7}$  cm<sup>2</sup>/s. This is not significantly different from the value that would be expected in water. Using the data from studies involving the migration of cells into clots, an equivalent diffusion coefficient of over  $10^8$  cm<sup>2</sup>/s was obtained. This indicates that even if fibronectin and cells were added at the same time that the diffusion of fibronectin would not be rate-limiting in relation to cell migration. In fact, in some of the reported experiments, fibronectin was added 24 h before the cells.

The structure of the fibronectin molecule has been studied in detail. The protein contains a domain that includes a fibrin-binding region (27, 28) and a domain that includes a cell surface binding site (7, 25). The two binding sites of the protein would seem to offer an obvious mechanism in which the cross-linked fibronectin provides the points of adhesion for cells on the fibrin lattice. However, the results here show that fibroblasts can adhere, spread, and migrate on fibrin lattices in the absence of fibronectin. Thus, there must be other sites on the fibrin lattice to which cells can become attached.

The cross-linking of fibronectin to fibrin is known to affect the physical characteristics of the clot. Thus, the shear modulus of fibrin is increased by the cross-linking of fibronectin (13).

Cells could migrate on the surface of clots in the absence of fibronectin and so it is necessary to question the mechanism in which fibronectin promotes migration into plasma clots. Recently it has been shown that fibronectin brings about a rapid movement of cells from collagen gels that did not contain fibronectin into contiguous areas of gel that did contain physiological concentrations of fibronectin (22). This translocation of cells was a function of the chemomechanical properties of the matrix in that polystyrene beads were also found to move rapidly but only during periods of collagen fibrillogenesis. Although we report here that fibronectin brings about a movement of cells into a fibrin mesh, it is unlikely that the mechanism involves "matrix-driven translocation." First, cells were not added until after the completion of fibrin fibrillogenesis. Second, matrix-driven translocation is unidirectional, whereas migration in plasma clots is random. Cells in plasma clots showed a non-uniform morphology. However, within the lattice structure of a clot, fibroblasts assume a three-dimensional configuration, whereas on a solid substratum the morphology is essentially two-dimensional.

*In vivo*, it is possible that cell migration is chemotactic. Platelet-derived growth factor has been shown to exert a chemotactic influence on fibroblasts (29). Platelet factors were not present in the plasma clots used in the studies reported here. We intend to now study the effects of platelets and platelet factors in fibroblast migration into clots.

We thank the Medical Research Council for financial support.

Received for publication 7 September 1985, and in revised form 4 March 1986.

## References

1. Alami, S. Y., J. W. Hampton, G. J. Race, and R. J. Speer. 1968. Fibrin stabilizing factor (factor XIII). *Am. J. Med.* 44:1-7.
2. Barnes, D. W., and J. Silnuzter. 1983. Isolation of human serum spreading factor. *J. Biol. Chem.* 258:12548-12552.
3. Barnes, D. W., J. Silnuzter, C. See, and M. Shaffer. 1983. Characterization of human serum spreading factor with monoclonal antibody. *Proc. Natl. Acad. Sci. USA.* 80:1362-1366.
4. Beck, E., F. Duckert, and M. Ernst. 1961. The influence of fibrin stabilizing factor on the growth of fibroblasts in vitro and wound healing. *Thromb. Diath. Haemorrh.* 6:485-491.
5. Curtis, A. S. G., J. V. Forrester, C. McInnes, and F. Lawrie. 1983. Adhesion of cells to polystyrene surfaces. *J. Cell. Biol.* 97:1500-1506.
6. Duckert, F. 1972. Documentation of the plasma factor XIII deficiency in man. *Ann. NY Acad. Sci.* 202:190-198.
7. Gold, L. I., A. Garcia-Pardo, B. Frangione, E. C. Franklin, and E. Pearlstein. 1979. Subtilisin and cyanogen bromide cleavage products of fibronectin that retain gelatin-binding activity. *Proc. Natl. Acad. Sci. USA.* 76:4803-4807.
8. Grinnell, F., and D. Minter. 1978. Attachment and spreading of baby hamster cells to collagen substrata: effects of cold insoluble globulin. *Proc. Natl. Acad. Sci. USA.* 75:4408-4412.
9. Grinnell, F., M. Feld, and D. Minter. 1980. Fibroblast adhesion to fibrinogen and fibrin substrata: requirement for cold-insoluble globulin (plasma fibronectin). *Cell.* 19:517-525.
10. Hayman, E. G., M. D. Pierschbacher, Y. Ohgren, and E. Ruoslahti. 1983. Serum spreading factor is present at the cell surface in tissues. *Proc. Natl. Acad. Sci. USA.* 80:4003-4007.
11. Hayman, E. G., and E. Ruoslahti. 1979. Distribution of fetal bovine serum fibronectin and endogenous rat cell fibronectin in extracellular matrix. *J. Cell Biol.* 83:255-259.
12. Hynes, R. O., and K. M. Yamada. 1982. Fibronectins: multifunctional modular proteins. *J. Cell Biol.* 95:369-377.
13. Kamykowski, G. W., D. F. Mosher, L. Lorrain, and J. D. Ferry. 1981. Modification of shear modulus and creep compliance of fibrin clots by fibronectin. *Biophys. Chem.* 13:25-28.
14. Kasai, S., T. Kunitomo, and K. Nitta. 1983. Cross-linking of fibrin by activated factor XIII stimulates attachment and proliferation of fibroblasts. *Biomed. Res.* 4:155-160.
15. Knox, P. 1984. Kinetics of cell spreading in the presence of different concentrations of serum or fibronectin-depleted serum. *J. Cell Sci.* 71:51-59.
16. Knox, P., and S. Griffiths. 1979. A cell spreading factor in human serum that is not cold insoluble globulin. *Exp. Cell Res.* 123:421-424.
17. Knox, P., and S. Griffiths. 1980. The distribution of cell-spreading activities in sera: a quantitative approach. *J. Cell Sci.* 46:97-112.
18. Knox, P., and S. Griffiths. 1982. The abnormal morphology of polyoma-transformed baby hamster kidney cells is due to a failure to respond to 70K spreading factor. *J. Cell Sci.* 55:301-316.
19. Martin, G. R., and H. Rubin. 1974. Effect of cell adhesion to the substratum on the growth of chick embryo fibroblasts. *Exp. Cell Res.* 85:319-333.
20. Mosher, D. F. 1975. Cross-linking of cold-insoluble globulin by fibrin-stabilizing factor. *J. Biol. Chem.* 250:6614-6621.
21. Mosher, D. F. 1976. Action of fibrin-stabilizing factor on cold-insoluble globulin and  $\alpha$ -2-macroglobulin in clotting plasma. *J. Biol. Chem.* 251:1639-1645.
22. Newman, S. A., D. A. Frenz, J. J. Tomasek, and D. D. Rabuzzi. 1985. Matrix-driven translocation of cells and nonliving particles. *Science (Wash. DC).* 228:885-889.
23. Nozawa, R. T. 1977. Altered morphology and increased cell adhesiveness of Chinese hamster ovary cells cultured on fibrin. *J. Cell. Physiol.* 90:351-360.
24. Nozawa, R. T., and R. L. Guerrant. 1977. Fibrin adherent CHO cell behavior in response to chelators and enterotoxin. *Exp. Cell Res.* 107:25-30.
25. Pierschbacher, M. D., E. G. Hayman, and E. Ruoslahti. 1981. Location of the cell attachment site in fibronectin with monoclonal antibodies and proteolytic fragments of the molecule. *Cell.* 26:259-267.
26. Schor, S., and J. Court. 1979. Different mechanisms in the attachment of cells to native and denatured collagen. *J. Cell Sci.* 38:267-281.
27. Sekiguchi, K., and S. Hakamori. 1980. Identification of two fibrin-binding domains in plasma fibronectin and unequal distribution of these domains in two different subunits: a preliminary note. *Biochem. Biophys. Res. Commun.* 97:709-715.
28. Sekiguchi, K., and S. Hakamori. 1983. Topological arrangement of four functionally distinct domains in hamster plasma fibronectin: a study with combination of S-cyanylation and limited proteolysis. *Biochemistry.* 22:1415-1422.
29. Seppa, H., G. Grotendorst, S. Seppa, E. Schiffman, and G. R. Martin. 1982. Platelet-derived growth factor is chemotactic for fibroblasts. *J. Biol. Chem.* 92:584-588.
30. Stenn, K. S., J. A. Madri, T. Tinghitella, and V. P. Terranova. 1983. Multiple mechanisms of dissociated epidermal cell spreading. *J. Cell Biol.* 96:63-67.
31. Stoker, M. G. P., C. O'Neill, S. Berryman, and V. Waxman. 1968. Anchorage and growth regulation in normal and virus transformed cells. *Int. J. Cancer.* 3:683-689.
32. Thom, D., A. J. Powell, and D. A. Rees. 1979. Mechanism of cellular adhesion. IV. Role of serum glycoproteins in fibroblasts spreading on glass. *J. Cell Sci.* 35:281-305.
33. Ueyama, M., and T. Urayama. 1978. The role of factor XIII in fibroblast proliferation. *Jpn. J. Exp. Med.* 48:135-142.
34. Wolpert, L., I. Macpherson, and I. Todd. 1968. Influence of serum on attachment of tissue cells to glass surfaces. *Nature (Lond.)* 223:512-513.