

Anomalous Rectification in the Squid Giant Axon Injected with Tetraethylammonium Chloride

CLAY M. ARMSTRONG and LEONARD BINSTOCK

From the National Institutes of Health, Bethesda. Dr. Armstrong's present address is the Department of Physiology, University College, London, England

ABSTRACT The injection of tetraethylammonium chloride into the giant axon of the squid prolongs the action potential and eliminates most of the late current under voltage-clamp. Experiments on fibers in an external medium of high potassium ion concentration demonstrate that injected tetraethylammonium chloride causes rectification of the instantaneous current-voltage curve for potassium by excluding outward current. This interference with the flow of outward potassium ion current underlies the prolongation of the action potential seen in tetraethylammonium-injected fibers.

INTRODUCTION

The first experiments involving tetraethylammonium ion (TEA^+) injection into an axon were performed by Tasaki and Hagiwara (1957). Three interesting points emerged from their experiments. (*a*) TEA^+ injection prolongs the action potential and produces a plateau similar to that seen in heart muscle fibers. (*b*) There is very little late current under voltage-clamp conditions. (*c*) Membrane conductance during the plateau of the action potential is comparable to the resting membrane conductance. FitzHugh (1960; see also George and Johnson, 1961) demonstrated that the Hodgkin-Huxley nerve equations could reproduce the first two points if the turn-on rate of g_{K} were slowed a hundredfold. He found, however, that this modification predicted a membrane conductance (g_m) during the plateau that was five times the resting membrane conductance. This can be understood in a simple way from the equivalent circuit proposed by Hodgkin and Huxley (1952 *d*), or from the Goldman equation (Hodgkin and Katz, 1949). During the plateau g_{Na} is larger relative to g_{K} and g_{leak} , than at rest, since the potential is closer to the equilibrium potential of Na^+ . If g_{K} and g_{leak} are the same at rest and during the plateau, then total membrane conductance, the sum of $g_{\text{K}} + g_{\text{Na}} + g_{\text{leak}}$, must be increased during the plateau. This prediction is in conflict with the conclusions of Tasaki and Hagiwara.

Clearly the problem could be solved in principle by allowing g_K to be less during the plateau than at rest. This is exactly what Noble (1962) has proposed to explain the low conductance plateau of sheep Purkinje fibers. These fibers have the property of "anomalous rectification" (*e.g.*, shown by Katz, 1949, for the frog sartorius); *i.e.*, g_K decreases as the fiber is depolarized, instead of increasing as it normally does in the squid axon. Noble postulates that this anomalous rectification is instantaneous, and causes g_K early in the plateau to be less than it is at rest. A slow increase of g_K brings about repolarization of the fiber.

The experiments reported here demonstrate that the instantaneous current-voltage curve for K^+ does indeed rectify anomalously when TEA^+ is injected, and suggest an electrical model for the injected fiber.

METHOD

Voltage-clamp apparatus and technique have been extensively described elsewhere (Cole and Moore, 1960). Certain modifications of this technique which were used in these experiments were described in a previous paper (Armstrong and Binstock, 1964).

Axons of *Loligo pealii* were injected with tetraethylammonium chloride (Eastman Kodak) by means of a cannula inserted from one end. The cannula was connected to a thin piece of polyethylene tubing of known diameter, and solution was forced into the axon by pinching the tubing. The cannula was withdrawn as the injection proceeded, to provide a uniform distribution of TEA^+ over the length of the axon (3 cm). The amount injected could be estimated from the length of tubing evacuated. This amount was usually slightly less than a microliter of 0.25 M TEA^+ (in distilled water), enough to make the axoplasm about 40 mM in TEA^+ .

The instantaneous current-voltage curve for the Na^+ -permeable membrane (Hodgkin and Huxley, 1952 *b*) was determined by a sequence of three voltage steps. (*a*) A hyperpolarizing conditioning step to remove inactivation of the sodium conductance. Unless noted otherwise, such a step was used in all voltage clamp-experiments in artificial sea water. (*b*) A depolarizing step usually to V_m approximately zero, for about half a millisecond, to increase the Na^+ conductance. (*c*) A variable step applied during the period of high Na^+ conductance. Current was measured as soon as possible after the third step (about 20 microseconds), and plotted as a function of membrane potential (V_m) during the third step. Instantaneous membrane conductance was measured by applying voltage steps to the axon and measuring the current immediately (20 microseconds) after. Hyperpolarizing steps of 20 to 60 mv were used to determine resting g_m .

"Compensated feedback" was used (Hodgkin *et al.*, 1952). The compensating signal was equivalent to the IR drop in a series resistance of 5 to 10 ohm cm^2 . These values were selected rather arbitrarily, but series resistance errors are not of very great significance in the present work.

All experiments were performed at 3–6°C. The external solutions employed are given in Table I. No corrections were made for junction potentials. Action potentials

TABLE I
CONCENTRATIONS OF SOLUTIONS

Solution	Na ⁺	K ⁺	Cl ⁻	Ca ⁺⁺	Mg ⁺⁺	Isethionate ⁻	Choline	TEA ⁺	Tris buffer
	mM/liter	mM/liter	mM/liter	mM/liter	mM/liter	mM/liter	mM/liter	m/liter	m/liter
ASW	430	10	560	10	50				0.5
100 mM K ⁺	340	100	560	10	50				0.5
440 mM K ⁺	0	440	560	10	50				0.5
43 mM Na ⁺	43	10	560	10	50		387		0.5
17 mM Na ⁺	17	10	560	10	50		413		0.5
Isethionate SW	430	10	130	10	50	430			0.5
100 mM K ⁺ and choline	205	100	565	10	50		130		0.5
100 mM TEA ⁺ and 100 mM K ⁺	240	100	560	10	50			100	0.5

were measured under space clamp conditions. Axon diameter ranged from 425 to 650 microns.

The Effects of TEA⁺ Injection

RESTING POTENTIAL Normal resting potential was 55 to 59 mv. Resting potentials of injected axons were generally somewhat lower (Table II). The low final values of resting potential (RP) and action potential (AP) in Table II are in most cases the after-effect of immersion in high K⁺ solutions.

ACTION POTENTIAL The action potential was usually somewhat smaller than that of a normal fiber (Table II). It was prolonged to varying degrees and sometimes

TABLE II

Axon	TEA ⁺	-RP	AP		ξ_m rest	ξ_m late	ξ leak	I_{in} (max)	I_{out} (max)	Temperature
			Size	Duration						
		mv	mv	msec.	mMhos	mMhos	mMhos	ma/cm ²	ma/cm ²	°C
B25		58-58	110-80	3				2.3	2.9	5.0
B26		58-52	102-100	4				2	5.2	6.2
B32		50-46	76-0	4				1.2	1.3	3.5
B39		58-41	96-0	4.8				2.4	4.0	3.5
B41		59-38	102-0	4				3.3	8.3	4.3
B42		57-57	96-96	4				1.7	4.3	3.8
B47		51-13	96-0	4.2				—	—	3.5
B24	Yes	51-50	96-90	10				1.2	0.3	5.0
B27	"	51-47	92-80	57				0.9	0.2	5.5
B33	"	48-42	90-40	18	0.64	1.66	1.20	0.9	0.3	4.0
B34	"	43-0	40-0	7				0.4	0.1	3.5
B35	"	43-19	60-0	10	0.36	0.82	0.48	0.3	0.1	3.5
B37	"	48-20	0					0.6	0.3	4.0
B40	"	53-31	84-0	12				1.0	0.3	3.5
B44	"	61-24	90-80	25	0.45	1.75	0.54	0.6	0.2	3.0
B45	"	61-5	90-0	14				1.1	0.3	3.5

had a plateau (Fig. 2 *b*). The presence or absence of a plateau could not be related to the axoplasmic TEA⁺ concentration in these experiments, because of the difficulty and inaccuracy of the injection procedure. In subsequent experiments on another species (*Dosidicus gigas*), which has much larger and more tractable axons, the action potential duration was found to increase with the internal TEA⁺ concentration.

VOLTAGE CLAMP EXPERIMENTS Typical current records for an injected fiber subjected to various voltage steps are shown in Fig. 1. The early, or transient, current looks normal. The notable feature is the paucity of late current (*cf.* Tasaki and Hagiwara, 1957). Maximum inward and outward current densities for a number of normal and injected axons are given in Table II.

Three parts abstracted from the current records of injected fibers, namely, the leakage current, the peak early current, and the late current, are plotted in Fig. 2.

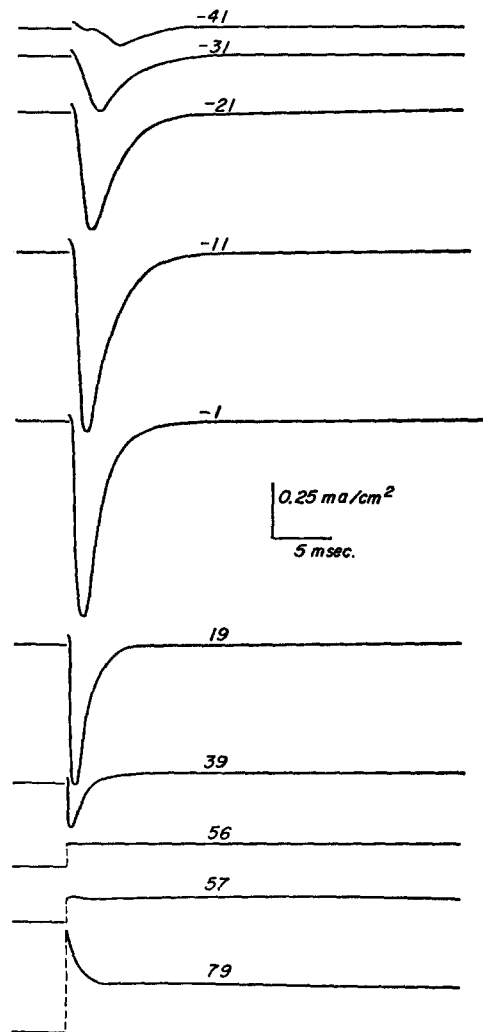

FIGURE 1. Voltage-clamp currents of a TEA⁺-injected axon in ASW following step depolarization to the potential given (millivolts). Depolarization was preceded by a hyperpolarizing step. Inward current is down in this and all other figures. Axon B27, 5°C.

Fig. 3 gives comparable plots for a normal axon. The leakage current, indicated by the dotted line, is interpolated from measurements of the current flowing at E_K (estimated as -90 mv, from the usual figure for internal K^+ concentration) following steps from the resting potential, and measurements of the current flowing at E_{Na} (the potential at which dI/dt is zero immediately after the test step) following a hyperpolarizing conditioning step (Adelman and Taylor, 1961). The points near V_m equal -10 and $+10$ were obtained by changing the external $[Na^+]$, thus changing E_{Na} .

The early current behaves in all respects the same as the Na^+ current of the normal axon, with the exception that current density is about half that expected for a normal fiber. The equilibrium potential (as defined above) of the early current is transferred

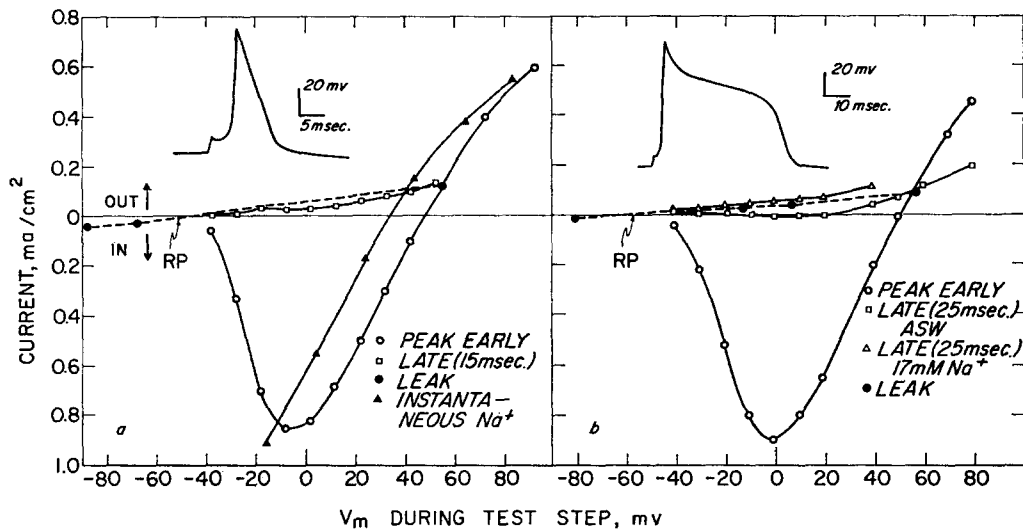

FIGURE 2. Current-voltage curves of two injected axons in ASW, measured with reference to the zero current line. Instantaneous Na^+ : see Methods. *a*, axon B33, $4^{\circ}C$. *b*, axon B27, $5^{\circ}C$.

from $+56$ to $+5$ mv, a change of 51 mv, when the external $[Na^+]$ is reduced tenfold, close to the 55 mv change predicted for a perfect Na^+ electrode at this temperature ($5^{\circ}C$). The time course of the rise and fall of the early current was not studied in detail, but seems normal in Fig. 1. The voltage dependence of the peak early current (Fig. 2) is almost the same as that of a normal fiber (Fig. 3 *b*). The instantaneous current-voltage curve (see Methods) taken during the early current period is similar for an injected (Fig. 2 *a*) and for a normal (Fig. 3 *b*) axon. (In both cases the instantaneous curve was determined considerably later than the peak current curve. Hence the difference in equilibrium potential between the instantaneous and peak curves.) Finally, the inactivation (Hodgkin and Huxley, 1952 *c*) of the early conductance by depolarizing conditioning steps, tested in two experiments, has a normal voltage dependence. Thus it seems safe to conclude that the early current of the injected fiber is similar to that of the normal fiber, and that it is carried by Na^+ (Hodgkin and Huxley, 1952 *a*).

The late current, on the other hand, is very small compared to that of a normal fiber, and remains small even if the depolarizing test step is extended to 2 seconds. This aberrant late current can largely be explained as the sum of a time-invariant leakage current, determined as described above, and a late Na^+ current. Thus the late current curve in ASW (Fig. 2 *b*) dips below the leakage current curve in a way that conforms to the shape of the peak early curve. This can be most easily explained

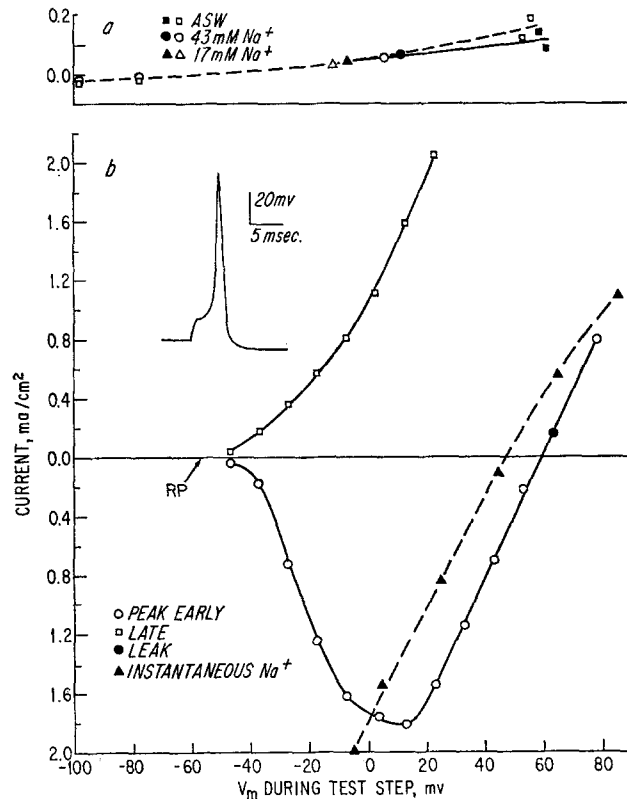

FIGURE 3 *a*. Leakage current of two normal axons (B25, B26). 3 *b*. Action potential and voltage-clamp currents for a normal axon in ASW measured with reference to the zero current line. Axon B42, 3.8°C.

by assuming that at 25 msec. g_{Na} has decayed to about one-twentieth of its peak value. Further support for this view comes with removal of most of the Na^+ from the external medium, which reduces the inward Na^+ current to almost zero, and makes the late current curve very nearly coincide with the leakage current curve (Fig. 2 *b*). g_{K} during the late period is thus inappreciable.

In three experiments g_m was measured in the late period following voltage steps which brought V_m near zero; *i.e.*, under conditions resembling those of the action potential plateau. g_m thus determined was two or three times resting g_m (Table II).

The leakage current is an almost linear function of V_m for both the injected and

the normal axon (Figs. 2 *b* and 3 *a*). In both cases, g_{leak} more than accounts for resting g_m , implying that resting g_K is very small (*cf.* Armstrong and Binstock, 1964). g_{leak} does not change with time (Fig. 1, depolarization to 56 mv).

The delicate balance that determines the presence or absence of a plateau in the action potential may be appreciated by comparing the two injected axons of Fig. 2. The slight difference in the late current curves (that of 2 *b* intersects the zero current line, while in 2 *a* there is an outward, repolarizing current at all potentials) determines the much more marked difference in the action potentials.

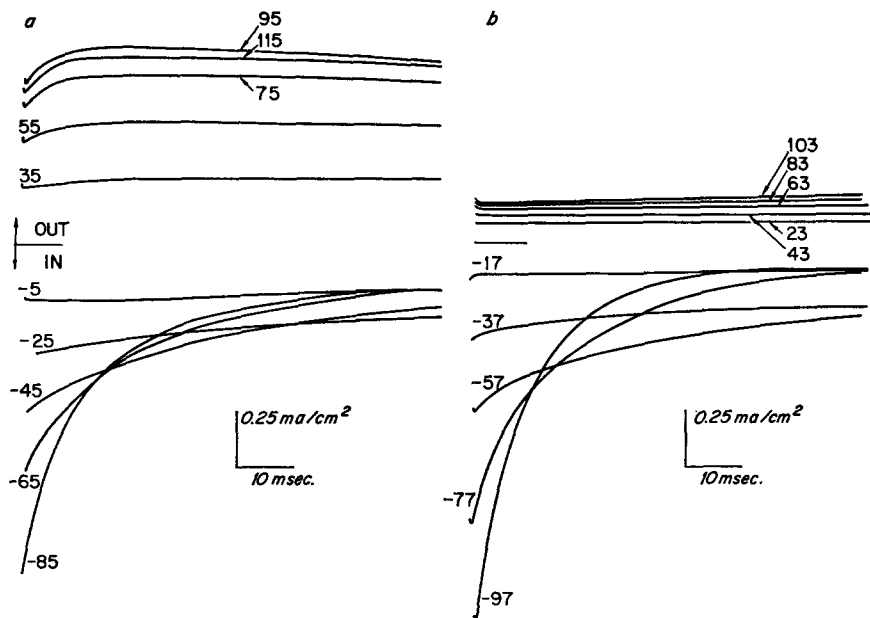

FIGURE 4. Superimposed voltage-clamp currents of fibers in 440 mM K^+ for voltage steps to the value given (millivolts). Fibers were held at unclamped resting potential until application of the step. *a*, un.injected (axon B39, 3.5°C). *b*, injected (axon B37, 4°C).

EXPERIMENTS IN HIGH EXTERNAL K^+ Thus far the K^+ permeability of the membrane seems simply to be shut off, as there have been no indications of a significant K^+ current in the voltage-clamp records. Raising the external $[K^+]$, however, depolarizes the injected axon, and the dependence of the resting potential on external $[K^+]$ is the same as for an un.injected fiber. Voltage steps applied to voltage-clamped normal and injected fibers in 440 mM external $[K^+]$ produce the currents seen in Fig. 4. The outward currents are for steps from +20 to +100 mv (*i.e.* depolarizing steps) in 20 mv increments and the inward currents for hyperpolarizing steps from -20 to -100 mv. The most obvious difference between the two records is the very small size of the outward current in the injected fiber. In both records the inward currents decrease with time in roughly the expected way (Hodgkin-Huxley, 1952 *a*), and this decrease can easily be shown to be the result of a conductance decrease. Substitution of isethionate ion for most of the external Cl^- leaves these currents un-

changed, and since Mg^{++} and Ca^{++} are not likely carriers, the currents must be largely K^+ . There are two slight differences between the inward currents of the TEA^+ and the normal fiber. The first is a peak about 200 microseconds after the application of the hyperpolarizing voltage steps to the TEA^+ fiber, faintly visible in Fig. 4*b*. The current increases and then decreases, while in the normal fiber it begins to decrease immediately. Although this peak could be obliterated by suitable adjustment of the feedback system, it was never seen with normal fibers, and later experiments (on

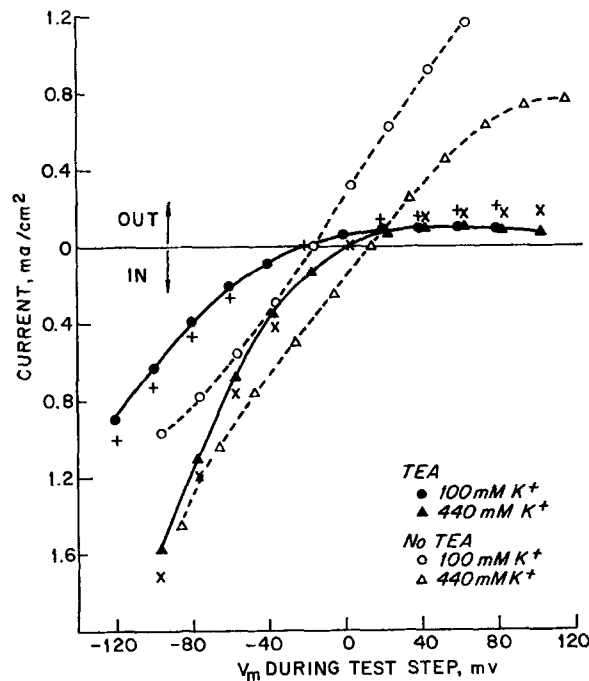

FIGURE 5. Current-voltage curves of axons in high K^+ measured 200 microseconds after steps from the unclamped resting potential. X's and +'s give membrane current of injected axon before subtraction of leakage current. TEA^+ curves were determined on a single fiber (B37, $4^\circ C$), controls on two different fibers (100 mM K^+ , B47, $3.5^\circ C$; 440 mM K^+ , B39, $3.5^\circ C$).

Dosidicus gigas) have convinced us that it is probably real. The second difference is that for a given polarizing potential, the decay of the (inward) current in the injected fiber is somewhat slower (by a factor of two or less).

The currents of Fig. 4 were measured 200 microseconds after the application of the voltage step, and plotted in Fig. 5 as a function of V_m during the step. The original curves for the TEA^+ experiments are given by the X's and +'s, while the solid curves are the same except for the subtraction of a linear leakage current, determined as described above. (It is assumed that g_{leak} is unchanged by raising the external $[K^+]$.) The rectification of the curves for the injected fibers is very marked. g_m determined 100 mv above and below the resting potential (in high $[K^+]$) is tabulated for several similar experiments in Table III.

The conductance for inward K^+ current, then, is approximately normal for the injected fiber in high external $[K^+]$, and decreases in an approximately normal manner when the fiber is hyperpolarized; while the conductance for outward K^+ current is small. The time course of the increase of this unidirectional g_K was determined by the experiment shown in Fig. 6. The fiber (TEA⁺-injected) was in 100 mM K^+ . V_m was held at a hyperpolarized value (-113 mv) for approximately 100 msec., and then changed to the depolarized values given in the figure. When the depolarization was maintained, there was a Na^+ current transient and a small late current. Repolarization of the fiber to -113 mv at various times after the depolarization produced the decaying current tails seen in the figure. The tails decay at two rates. With repolariza-

TABLE III

Axon	TEA ⁺	$[K^+]_{ext}$	RP	g_m (RP + 100 mv)	g_m (RP - 100 mv)
		mM	mv	mMhos	mMhos
B32		200	0	10.5	19.0
B39		100	-10	3.1	3.5
		440	15	7.8	13.5*
B41		100	-12	12.0	8.8*
		440	8	14.0	15.5
B47		100	-19	12.0	7.0
B33	Yes	200	-1	1.2	4.6
B34	"	440	10	1.7	8.8
B35	"	100	-8	0.7	3.5
		440	3	0.8	5.4
B37	"	100	-20	2.4	10.0
		440	3	1.8	17.0
B40	"	100	-3	1.0	5.1
B44	"	100	-15	0.8	5.0
B45	"	100†	-19	1.2	3.6
		440	9	1.5	11.0

* g_m determined at RP-80.

† Fiber in 100 K^+ and choline.

tions during or shortly after the Na^+ transient, there is a rapidly decaying component (best seen in the depolarization to -33 mv) which results from decreasing Na^+ current. Both the rapidly decaying component and the Na^+ transient are absent when there is no external Na^+ . With progressively later repolarization, the rapid component becomes smaller and disappears; while a slowly decaying component, similar to the tails of Fig. 4, becomes larger. The slow component is undoubtedly decaying K^+ current. The initial amplitude of the slow component is therefore proportional to the K^+ conductance at the moment of repolarization. The records are similar to those of a normal fiber in the same circumstances (*i.e.* the time course of increase of K^+ conductance is approximately normal), but there are differences. One is the very small size of the outward current in the TEA⁺ axon for depolarizations beyond E_K (not shown in Fig. 6), a reflection of the rectification seen in Fig. 5. Another difference lies in the relation between steady-stage g_m (from the experiment of Fig. 6) and V_m , which is plotted in Fig. 7 for two normal and two injected fibers. The curves are some-

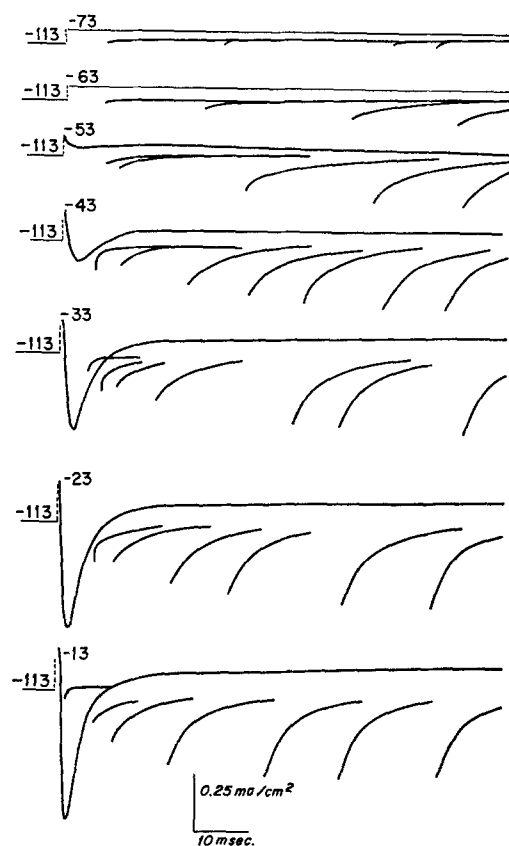

FIGURE 6. Superimposed voltage-clamp currents of a TEA⁺-injected fiber in 100 mM K⁺. Resting potential was -13 mv. The fiber was hyperpolarized to -113 mv for 100 msec., depolarized to the potential given, then repolarized to -113 mv. The current tails are the result of the repolarization. Axon B40, 3.5°C.

what scattered, but they differ distinctly in shape for the normal and for the injected fibers.

Experiments with External TEA⁺

The effects of external TEA⁺ were examined in two experiments. Soaking the nerve up to half an hour in a 100 mM TEA⁺ + 100 mM K⁺ solution affected the instantaneous current-voltage curve neither when Na⁺ permeability was high nor when K⁺ permeability was high. It may be inferred that membrane permeability to TEA⁺ is small, since rapid build-up of the internal TEA⁺ concentration could have been detected from its effect on the K⁺ current-voltage curve. It seems that TEA⁺ acts only on the inside of the membrane and affects only the K⁺ channels.

DISCUSSION

Much of the work presented here can be summarized by saying that TEA⁺ injected in sufficient quantity prevents the flow of outward K⁺ current. This accounts for the small size of the late current in ASW (Figs. 1 and 2), and the marked rectification of the instantaneous (or 200 microsecond) current curves

in high external $[K^+]$ (Figs. 4 and 5). The rectification is thus current-dependent rather than voltage-dependent, *i.e.* instantaneous conductance is a function of $V_m - E_K$ (where E_K is taken as the resting potential when the external $[K^+]$ is 100 mM or more), rather than of V_m (*cf.* Hodgkin and Horowitz, 1959; Noble, 1962). This is apparent in Fig. 8, where g_K is plotted as a function of V_m and of $V_m - E_K$. Only in the latter plot do the high $[K^+]$ curves and the ASW curve approximate to zero at the same point. The current dependence of the rectification has an interesting interpretation. Apparently TEA^+

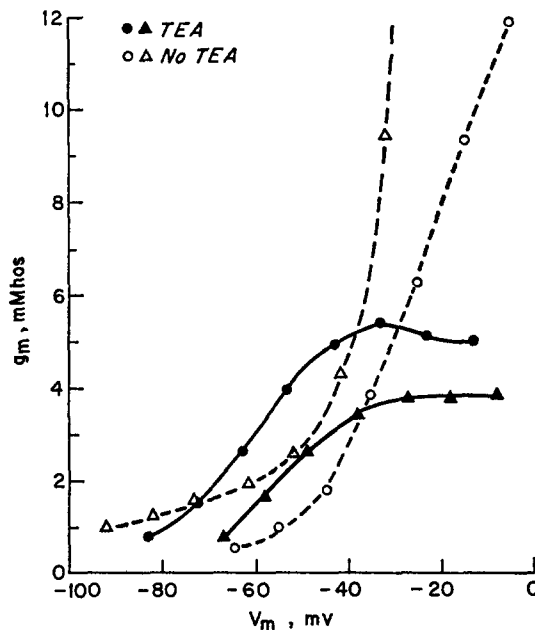

FIGURE 7. Steady-state g_m for fibers in 100 mM K^+ subjected to the procedure of Fig. 6. V_m is the potential to which the fiber was depolarized after the conditioning hyperpolarization. Open triangles, fiber in 100 mM K^+ and choline; axon B41, 4°C. Open circles, B39, 3.5°C. Filled circles, B40, 3.5°C. Filled triangles, B44, 3°C.

ions enter the membrane under conditions that should produce a net efflux of K^+ ions, and block the movement of K^+ , while a net influx of K^+ sweeps the membrane clear of TEA^+ .

This instantaneous, current-dependent rectification in the K^+ channel can be represented by inserting a diode (Fig. 9 *c*) in the equivalent circuit proposed by Hodgkin and Huxley (1952 *d*) for the normal nerve (Fig. 9 *a*). The diode is in series with the rheostat that represents the normal K^+ conductance. For the normal nerve, $g_K = \bar{g}_K n^4$ (Hodgkin and Huxley, 1952 *d*). n^4 is a variable dependent on V_m and time, which may be thought of as expressing the fraction of the K^+ channels that are open. \bar{g}_K is a constant which may be

thought of as expressing (a) the total number of K^+ channels and the conductance of each, and (b) the linearity of the instantaneous current-voltage curve for the K^+ -permeable membrane (Hodgkin and Huxley, 1952 *b*). TEA⁺ injection leaves n^4 substantially unchanged (there are some changes as noted

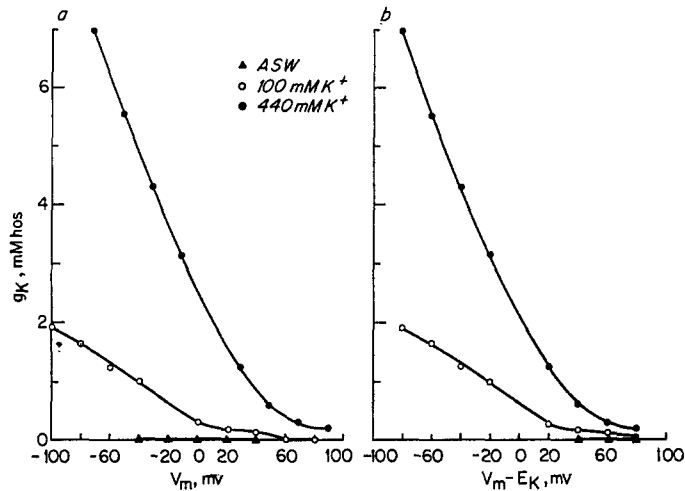

FIGURE 8. Instantaneous g_K plotted as a function of V_m and $V_m - E_K$. Filled triangles, axon B27, 5°C. Circles, axon B35, 3.5°C.

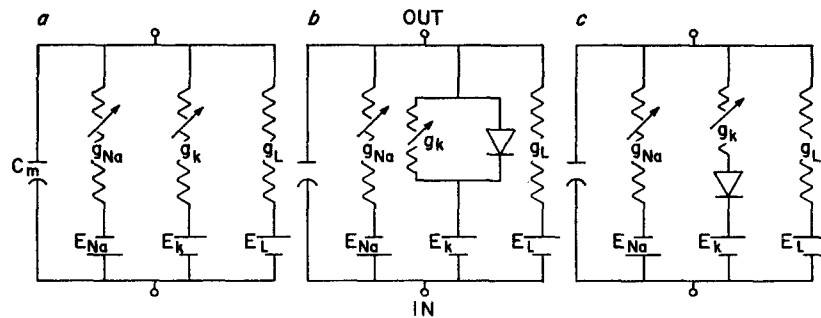

FIGURE 9. Proposed equivalent circuits for *a*, normal nerve (Hodgkin-Huxley); *b*, sheep Purkinje fiber (Noble); *c*, TEA⁺-injected nerve.

above), but replaces \bar{g}_K by a non-linear function that rectifies around E_K , to the exclusion of outward current (Fig. 5). In circuit 9 *c* the rheostat corresponds to n^4 , while the diode represents the non-linear curve that replaces \bar{g}_K . Functionally, the K^+ channel can be ignored, since resting and late g_K are very small in the injected fiber.

The remaining elements of circuit 9 *c* are essentially the same as those of the normal nerve. There are no changes in any of the parameters of g_{Na} which we examined except a reduction in magnitude. Interestingly, the leakage current-

voltage curve has approximately the same shape and magnitude in normal and injected fibers (Figs. 2 *b* and 3 *a*) even though there is evidence, at least for the myelinated frog fiber (Dodge, 1963), that the leakage current is largely carried by K^+ .

Fig. 9 *b* depicts the equivalent circuit proposed by Noble (1962) for the sheep Purkinje fiber. Noble has chosen the parameters of the circuit so that it will reproduce not only action potentials but also pacemaker activity. Our interest here lies only in the fact that the circuit produces a low conductance action potential plateau. Noble postulates two parallel components of the K^+ permeability: a voltage-dependent conductance of Hodgkin-Huxley type (the rheostat) but slower by a hundredfold and very small; and a second component, the diode, that rectifies anomalously (*i.e.*, to the exclusion of outward current). This circuit is not applicable to the TEA⁺-injected axon for several reasons. (*a*) In Fig. 4 *b* the rate of decrease of g_K on hyperpolarization is approximately normal, not slowed a hundredfold. (*b*) In Fig. 6 the rate of increase of g_K (unidirectional) following depolarization is approximately normal, not slowed a hundredfold. (*c*) In Figs. 4 *b* and 6 there is a K^+ current only when n^4 for a normal nerve would be greater than zero. This indicates that the diode and the rheostat are in series.

The Hodgkin-Huxley equations do not describe a process slow enough to account for the gradual repolarization that occurs during the plateau. Fitz-Hugh (1960), George and Johnson (1961), and Noble (1962) provide the long time constant process required by postulating a slow increase of K^+ conductance. Since the rate of increase of g_K is approximately normal in the TEA⁺-injected fiber, another explanation must be sought. A reasonable possibility is that the slow change of membrane impedance during the plateau (Tasaki and Hagiwara, 1957; Tasaki, 1959) results from the decrease of a depolarizing conductance; *e.g.*, g_{Na} .

If, as we propose, g_{Na} during the plateau is higher than its resting level, g_m should also be higher, since g_{leak} is unchanged, or slightly increased. (g_{leak} increases slightly with depolarization, but is independent of time.) This agrees with the measurements of Table II, but conflicts with the conclusions of Tasaki and Hagiwara (1957). The difference probably stems from the fact that our measurements were almost instantaneous, while their readings were taken at the end of 1 msec. current pulses, during which g_{Na} was changing. Such a change of g_{Na} is responsible for the horizontal (low conductance) portion of the late curve in Fig. 2 *b*. Indeed, the curvature of the late curve (Fig. 2 *b*) about the zero current intercept at 19 mv is reflected in their Fig. 5: the conductance for a polarizing current pulse is lower than for a depolarizing pulse. Their bridge measurements at 10 and 20 kc gauge more nearly the instantaneous impedance of the membrane, and these show a bridge imbalance during the plateau that could be the result of increased g_m .

The authors wish to express their appreciation to Dr. Kenneth S. Cole, Dr. Richard FitzHugh, and Dr. Robert E. Taylor and to other members of the Laboratory of Biophysics, for their cooperation and their helpful discussions and to the Marine Biological Laboratory, Woods Hole, Massachusetts, and Estacion de Biologia Marina, Viña del Mar, Chile, for their facilities and services. Received for publication, July 7, 1964.

REFERENCES

- ADELMAN, W. J., and TAYLOR, R. E., 1961, Leakage current rectification in the squid giant axon, *Nature*, **190**, 883.
- ARMSTRONG, C. M., and BINSTOCK, L., 1964, The effects of several alcohols on the properties of the squid giant axon, *J. Gen. Physiol.*, **48**, 265.
- COLE, K. S., and MOORE, J. W., 1960, Ionic current measurements in the squid giant axon, *J. Gen. Physiol.*, **44**, 123.
- DODGE, F., 1963, A study of ionic permeability changes underlying excitation in the myelinated nerve fibers of the frog, unpublished thesis, The Rockefeller Institute.
- FITZHUGH, R., 1960, Thresholds and plateaus in the Hodgkin-Huxley nerve equations, *J. Gen. Physiol.*, **43**, 867.
- GEORGE, E. P., and JOHNSON, E. A., 1961, Solutions of the Hodgkin-Huxley equations for squid axon treated with tetraethylammonium and in potassium rich media, *Australian J. Exp. Biol. and Med. Sc.*, **39**, 275.
- HODGKIN, A. L., and HOROWICZ, P., 1959, The influence of potassium and chloride ions on the membrane potential of single muscle fibers, *J. Physiol.*, **148**, 127.
- HODGKIN, A. L., and HUXLEY, A. F., 1952 *a*, Currents carried by sodium and potassium ions through the membrane of the giant axon of *Loligo*, *J. Physiol.*, **116**, 449.
- HODGKIN, A. L., and HUXLEY, A. F., 1952 *b*, The components of the membrane conductance in the giant axon of *Loligo*, *J. Physiol.*, **116**, 473.
- HODGKIN, A. L., and HUXLEY, A. F., 1952 *c*, The dual effect of membrane potential on sodium conductance in the giant axon of *Loligo*, *J. Physiol.*, **116**, 497.
- HODGKIN, A. L., and HUXLEY, A. F., 1952 *d*, A quantitative description of membrane current and its application to conduction and excitation in nerve, *J. Physiol.*, **117**, 500.
- HODGKIN, A. L., HUXLEY, A. F., and KATZ, B., 1952, Measurement of current-voltage relations in the membrane of the giant axon of *Loligo*, *J. Physiol.*, **116**, 424.
- HODGKIN, A. L., and KATZ, B., 1949, The effect of sodium ions on the electrical activity of the giant axon of the squid, *J. Physiol.*, **108**, 37.
- KATZ, B., 1949, Les constantes electriques de la membrane du muscle, *Arch. sc. physiol.*, **3**, 285.
- NOBLE, D., 1962, A modification of the Hodgkin-Huxley equations applicable to Purkinje fiber action and pace-maker potentials, *J. Physiol.*, **160**, 317.
- TASAKI, I., 1959, Demonstration of two stable states of the nerve membrane in potassium-rich media, *J. Physiol.*, **148**, 306.
- TASAKI, I., and HAGIWARA, S., 1957, Demonstration of two stable potential states in the squid giant axon under tetraethylammonium chloride, *J. Gen. Physiol.*, **40**, 859.