

THE ACTION OF AIR IONS ON BACTERIA

I. PROTECTIVE AND LETHAL EFFECTS ON SUSPENSIONS OF STAPHYLOCOCCI IN DROPLETS*

By A. P. KRUEGER, R. F. SMITH, AND ING GAN GO

(From the Department of Bacteriology, University of California, Berkeley)

(Received for publication, April 16, 1957)

ABSTRACT

Techniques have been devised for studying quantitatively the effects of air ions on microorganisms suspended in small drops. In smog-contaminated atmospheres moderate concentrations of positive and negative air ions exerted a protective effect on staphylococci by delaying the drop in pH customarily observed and by diminishing the rate of evaporation. In clean air higher concentrations of positive and negative air ions accelerated the rate of death of staphylococci apparently by direct action on the cells and by increasing the rate of evaporation.

Air ion action in these experiments did not involve cell agglutination or direct radiation from the radioactive isotopes employed.

INTRODUCTION

Air ions were first described in 1899 by Wilson (1) and by Elster and Geitel (2). Whether or not they exert any biological effects has been the subject of considerable controversy. Most of the tests have been conducted on disease processes in human beings and relatively little has been done with animals or simpler forms of life such as bacteria. The present paper presents the results of the initial phases of a research program undertaken to investigate the effects of positive or negative air ions on bacteria and viruses and is concerned altogether with one substrate, the K₁ strain of *M. pyogenes* var. *aureus*.

Materials and Methods

Air Ion Apparatus.—Three air ion generators of the type designed by Skilling and Beckett (Fig. 1) or that developed by Beckett and Hicks (Fig. 2) were installed in individual 10 × 12 × 31 inch plywood cabinets, equipped in front with sliding glass panels (Fig. 3). A zinc plate on the floor of each cabinet served as a ground, and an electrostatic field of 300 volts was maintained between it and the ion source. The Po²¹⁰ and H³ heads were detachable and could be plugged into the rectifying circuit of any cabinet, as desired. A dummy head was used in the control cabinet. The charge

*These studies were supported by grants from The Wesix Research Foundation of San Francisco and The Board of Research of the University of California.

of the emitted ions depended upon the polarity of the rectifier circuit, and could be reversed when necessary.

In experiments that required 100 per cent relative humidity, a sheet of flexible plastic was used to make a waterproof tent that enveloped both the ionizer head and the samples. Beakers of water with filter paper wicks were placed inside the tent to maintain a saturated atmosphere.

In experiments in which stirring of the samples was desired, magnetic micro-stirrers were placed inside the cabinets.

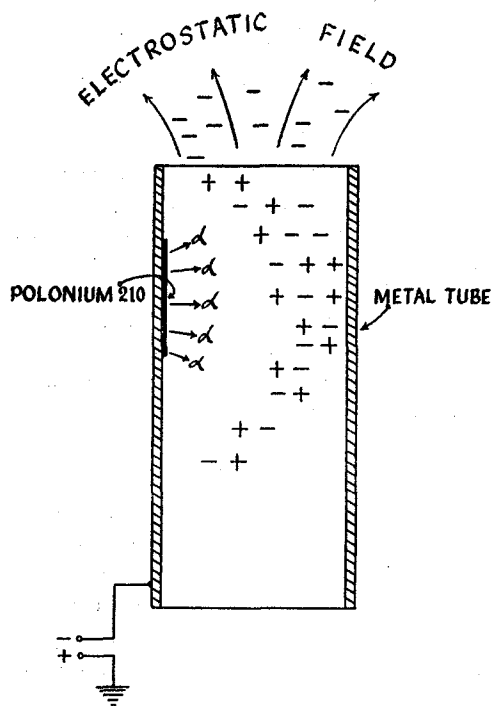

FIG. 1. Diagram of Po^{210} ionizer. α radiation produces (+) and (-) ions. Rectifying circuit removes undesired ions, in this instance (+) ions.

Microorganisms.—The K_1 strain of *M. pyogenes* var. *aureus* was transferred every 24 hours to a fresh trypticase soy 2 per cent agar plate. Cultures incubated at $36^\circ C$. and ranging in age from 12 to 16 hours were used.

In experiments in which the Po^{210} generator was the air ion source, K_1 suspensions were made directly from the agar plate. In later experiments employing the tritium generator, the cells were washed twice with 0.85 per cent saline before being suspended in distilled water.

Technique of Exposing Bacteria to Air Ions.—By means of micropipettes, 50 or 100 lambda samples of the K_1 suspension (in distilled water unless otherwise noted) were placed in individual porcelain microtitration dishes, the undersurfaces of which had

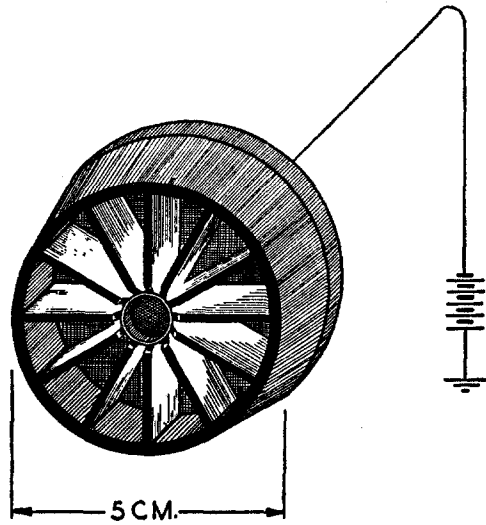

FIG. 2. H³ ionizer. Tritium foil air ionizer, holder, and electrode. The tritium foil is protected by a plastic head.

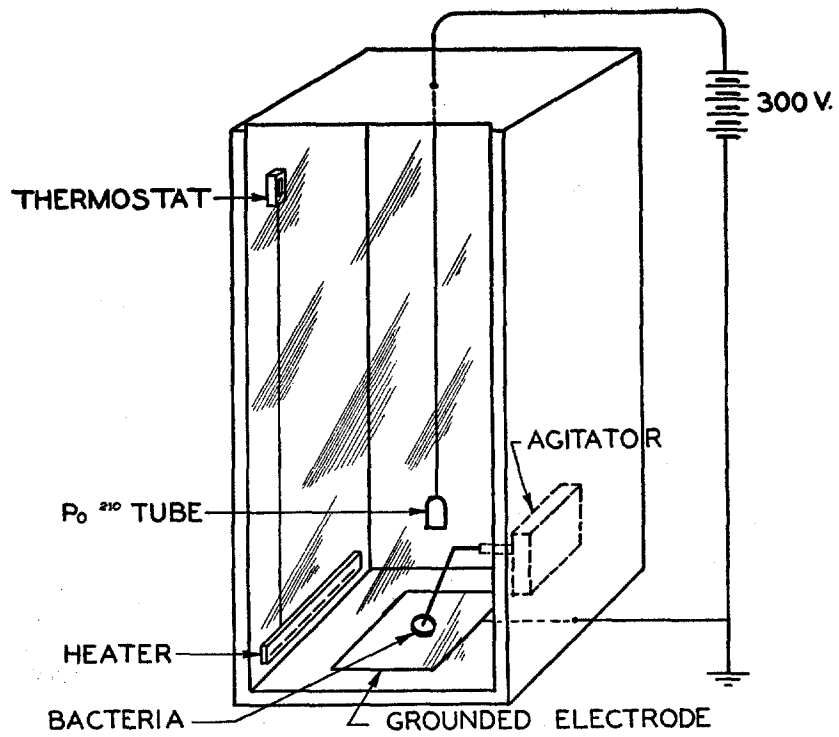

FIG. 3. Plywood cabinet arranged for exposure of microorganisms to unipolar air ions.

been previously treated with a static eliminator. The sample was placed on the zinc plate inside the cabinet under the ionizing head. If the sample was to be stirred, the fine glass rod of the microstirrer was put in place. Then the current in the rectifier circuit was turned on and the sample exposed for the desired length of time.

The samples were allowed to evaporate freely in some experiments. In others, they were kept roughly constant by additions of distilled water by micropipette. In a few experiments the volume was kept constant by maintaining 100 per cent relative humidity within a plastic tent, as described above.

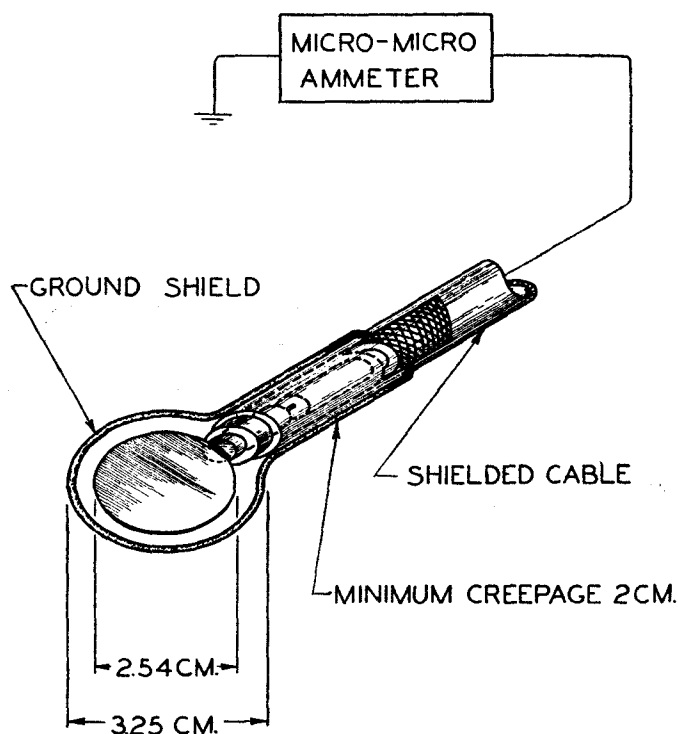

FIG. 4. Ion current probe; designed by J. C. Beckett.

Volume measurements on evaporating samples were made by drawing up the droplet into a microburette graduated in lambdas. pH measurements were made with a Beckman model G pH meter utilizing the one drop glass electrode. The numbers of air ions of either polarity impinging on a given area were determined by means of a special probe (Fig. 4) connected to a Beckman ultrahmeter. The current produced was read and was converted into ions/cm.²/sec. by substitution in the equation: $N = I/qA$ in which

I = current produced by ions

$q = 1.6 \times 10^{-19}$ coulombs

A = area of probe surface.

EXPERIMENTAL RESULTS AND DISCUSSION

There is no particular reason to anticipate that air ions should exert any detectable biological effects. Certainly their composition and velocities would provide no obvious basis for predicting such action: The small air ions consist of single ionized molecules about which cluster from 4 to 12 uncharged molecules and their mobilities are of the order of only 1 to 2 cm./sec./volt/cm., the positive ions moving somewhat more slowly than the negative ions. Intermediate ions are multiples of a unit cluster composed of approximately 2000 molecules and may range in size up to some 15 such units; their mobilities are correspondingly low: from 2×10^{-1} to 1×10^{-8} cm./sec./volt/cm. Pollock (3) considers very low humidity a condition essential to their formation.

Despite the lack of *a priori* grounds for postulating any action on living systems there exists a considerable literature extolling the therapeutic value of negative air ions in disease conditions such as hypertension, hay fever, asthma, etc. Dessauer (4), for example, has done a great deal of work in this field and considers that the inhalation of negative air ions will reduce the blood pressure, relieve migraine headaches, and combat fatigue. Evaluation of many of the earlier reports is extremely difficult, first because of the variability encountered in the study of a given morbid process and second because the methods employed for the production of air ions are open to criticism. Thus, high voltage brush discharges, while serving effectively to produce air ions also contribute to the atmosphere a variety of by-products such as ozone and the oxides of nitrogen. Again, in much of Dessauer's work finely divided MgO was utilized to carry the electric charge (4).

The difficulties involved in air ion generation have been largely overcome by the development of the unipolar polonium ion generator by Skilling and Beckett (5) and the tritium ion generator by Beckett and Hicks (6). The first apparatus utilizes alpha radiation from polonium to ionize the air and the second employs beta radiation derived from tritium. In each unit equal numbers of positive and negative ions are formed and selection of ions of either charge is accomplished by collecting the undesired ions on an electrode of opposite polarity (Fig. 1). While the unwanted ions are being discharged and ceasing to exist in the ionic state the selected ions are driven in the opposite direction by the electrostatic force. No adventitious by-products are formed.

The improved ion generators have been employed in studies on human beings and on animals. Kornbluh and Griffin (7) made a careful study of the effects of negative air ions on 27 patients suffering from hay fever, bronchial asthma, and related conditions. They report favorable results in 17 of these cases and a repetition of the results during the following year. Winsor (8) is conducting a very interesting study of the subjective and objective effects of air ions on the upper respiratory tract of human beings. He has observed that positive air ions

induce pronounced nasal obstruction, headache, dryness of the mucous membranes, husky voice, and dizziness. Concurrently, the maximal breathing capacity is reduced from 35 liters/minute to 25 liters/minute on the average. Negative air ions were much less active in bringing about any of these phenomena.

Similarly Yaglou and his colleagues (9) have reported irritation of the upper respiratory tract and headaches accompanying exposure to positive air ions. Negative ions brought about relaxation and mild euphoria. Nielsen and Harper (10) demonstrated that the succinoxidase content of the adrenal glands of rats maintained in positively ionized air was significantly reduced; negatively ionized air produced a slight but insignificant rise. Worden (11) found that the CO₂-combining power of the plasma of young hamsters was measurably increased by exposure of the animals to negative air ions. He also has noted (12) that the growth rate of selected organs was higher in hamsters maintained in an atmosphere containing an excess of negative air ions. The entire subject of the significance of air ions as an environmental factor has been reviewed by Murphy (13), Hicks (14), and more recently by Hicks and Beckett (15).

1. *Studies with the Polonium (Po²¹⁰) Generator.*—Our first experiments with air ions were in the nature of a survey and for the most part proved disappointing. Using the Po²¹⁰ generator as an ion source, we looked for any detectable effect of positive or negative ions on the growth of staphylococci, the motility and swarming of organisms such as *Proteus vulgaris*, the production of streptococcal hemolysin, etc.; the results were vague and not readily reproducible. However, as work went on, it became apparent that under some conditions, air ions influenced the death rate of staphylococci and we found that this could best be demonstrated under the following circumstances: (a) By using droplets of cell suspensions sufficiently small to provide a high ratio of surface area to volume. (b) By employing non-nutrient fluids; e.g., distilled water as the suspending menstruum. (c) By developing a technique suitable for handling bacteria in small drops and for allowing accurate quantitative estimation of viable cells in these drops. For this purpose the equipment and methods of microchemistry were adapted to bacteriological requirements.

Inadvertently all our early tests were conducted in atmospheres containing varying concentrations of smog. While the experiments in consequence are not well controlled the data have been included to emphasize the extent to which air pollutants can modify the results obtained.

Almost all the early experiments with air ions were performed by exposing to their action 100 lambda droplets of distilled water in which were suspended approximately 3×10^6 staphylococci. In these small drops death of cells normally (non-ionized controls) proceeds at an appreciably higher rate than is observed in volumes ranging from 5 to 10 ml. (Fig. 5). The die-away parallels a fall in pH

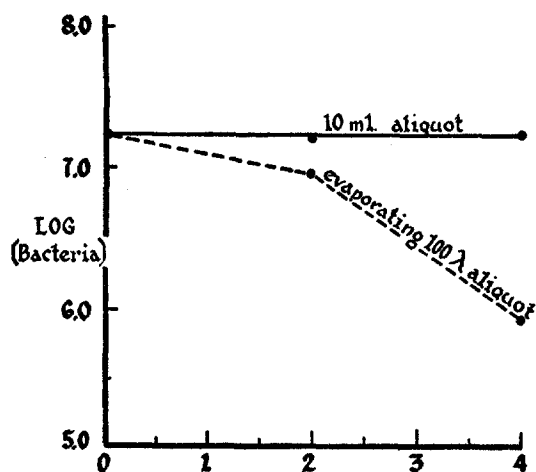

FIG. 5. Survival of staphylococci in 10 ml. and 100 lambda aliquots of distilled water. Free evaporation occurring; $B_0 = 1.8 \times 10^7$ cells/ml.; smog present.

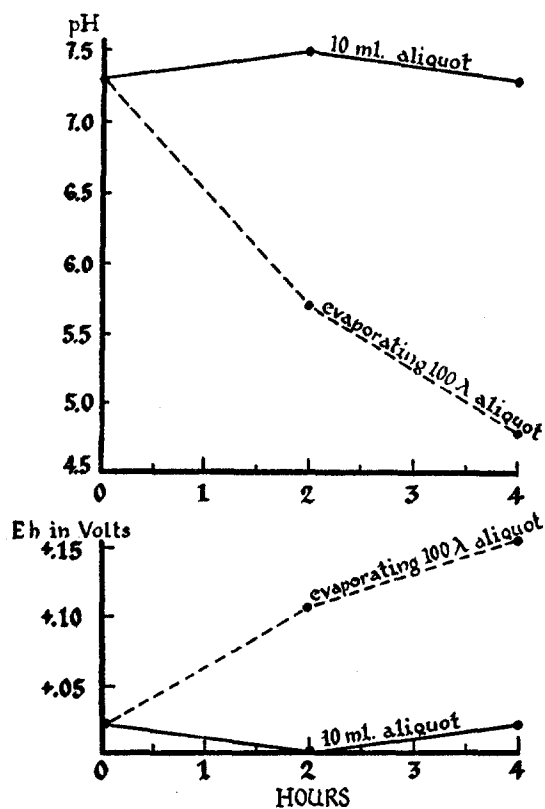

FIG. 6. pH and E_h shift in 10 ml. and 100 lambda aliquots of distilled water containing 1.8×10^7 staphylococci/ml. Free evaporation occurring in smoggy atmosphere.

from somewhat over 7 to values between 4 and 5 and a corresponding rise in Eh (Fig. 6). This is considerably more than can be ascribed to the absorption of CO_2 ; unidentified smog constituents appear to be responsible for much of the effect. There was considerable variation in the rate of fall of pH from day to day and in the rate of cell death (see controls in Figs. 7 and 8).

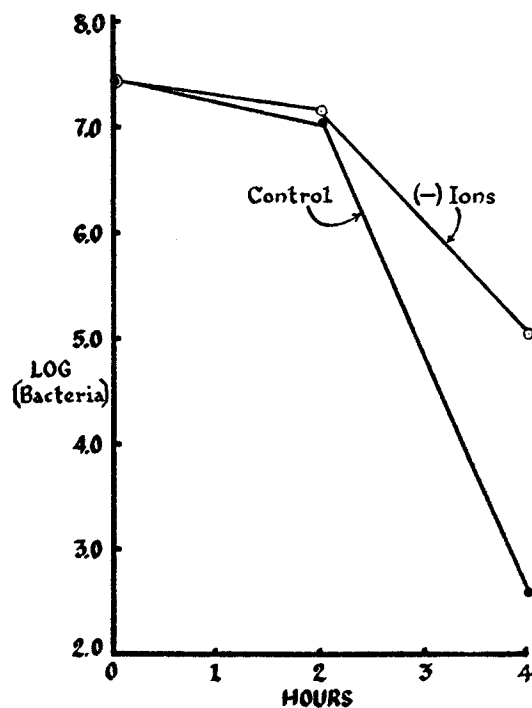

FIG. 7. Effect of negative air ions on survival of staphylococci in 100 lambda evaporating drop. Po^{210} ionizer $\rightarrow 1 \times 10^8$ ions/cm.²/sec. at 7.5 cm. R.H. 58 per cent; smog present.

When evaporation of 100 lambda droplets of distilled water containing staphylococci proceeded in the presence of negative or positive air ions the death rate curve was flatter. Here again, fluctuations occurred from day to day; at times the protective effect of air ions was marked as in Fig. 8 and on other occasions the effect was measurable but not impressive (Fig. 7). The charge of the ion seemed to have no clear-cut relation to the degree of protection afforded. The numbers of air ions impinging on 1 cm.²/sec. were measured with the Beckett probe (Fig. 4) and Beckman micromicroammeter. The average value for these experiments was 1×10^8 ions/cm.²/sec.

Measurements of pH were made during the evaporation of 100 lambda droplets of staphylococci suspended in distilled water and exposed to air ions. Both positive and negative air ions had a pronounced effect in delaying the fall in pH and also limited its extent (Fig. 9). Measurements of *Eh* paralleled the pH values.

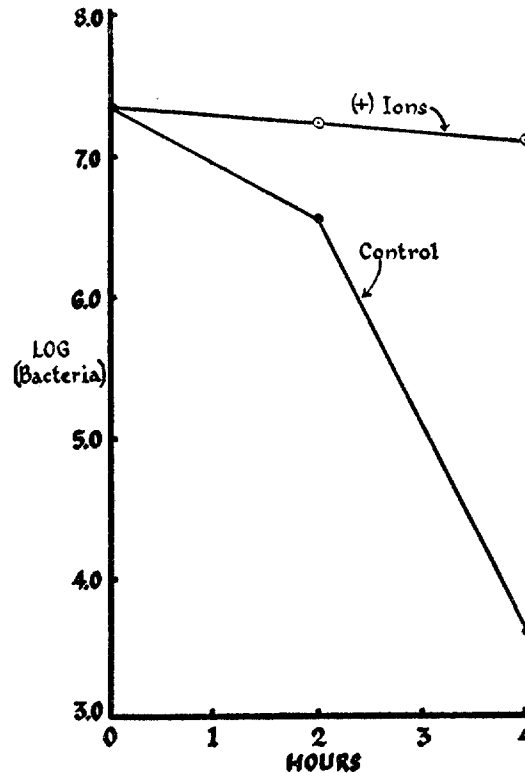

FIG. 8. Effect of positive air ions on survival of staphylococci in 100 lambda evaporating drop. Po^{20} ionizer $\rightarrow 1 \times 10^8$ ions/cm.²/sec. at 7.5 cm. R.H. 60 per cent; smog present.

The rate of evaporation of the 100 lambda droplets varied, of course, with the condition of the ambient air but, regardless of evaporation rate in the non-ionized controls, positive and negative air ions appreciably retarded this process (Fig. 10). The reduction in rate of evaporation may depend upon the continuous formation of large ions (Langevin ions) through the action of small ions on soluble substances normally present in industrial smokes (16). Such large ions are much more abundant in urban than in rural areas and are known

to serve as centers of condensation for water vapor present in the air. This mechanism could well account for the observed reduction in rate of evaporation.

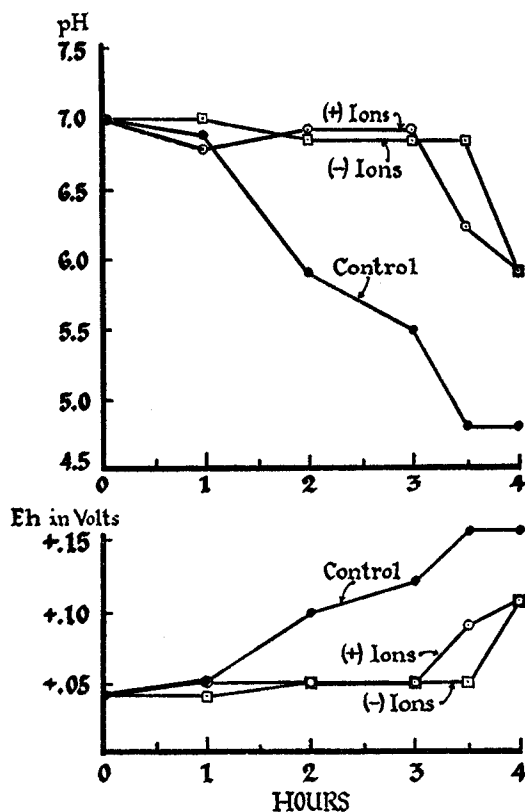

FIG. 9. Effect of air ions on pH and Eh shifts in 100 lambda evaporating drops containing staphylococci. Po^{210} ionizer $\rightarrow 1 \times 10^8$ ions/cm.²/sec. at 7.5 cm. R.H. 54 per cent; smog present.

To determine whether air ions have any effect on staphylococci when the volume and pH of the droplet are fixed, a constant volume chamber was devised. This consisted of a plastic canopy enclosing the ionizer-head, the test droplets, and 4 beakers of distilled water with filter paper wicks for maintenance of high humidity. The relative humidity remained very close of 100 per cent and the volume of 100 lambda samples did not vary more than 3 lambdas in the 4 hour experimental period; the pH remained above 7. Since there was no danger of solutes becoming concentrated by evaporation of the droplet, physiological saline solution was used in some of the experiments and distilled water

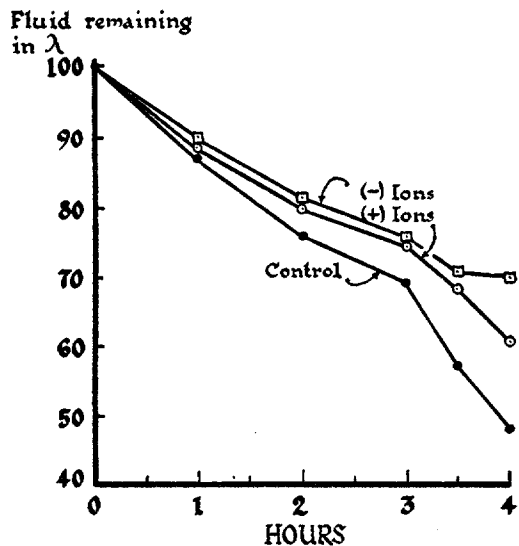

FIG. 10. Effect of air ions on rate of evaporation from 100 lambda drops containing staphylococci. Po^{210} ionizer $\rightarrow 1 \times 10^8$ ions/cm.²/sec. at 7.5 cm. R.H. 80 per cent; smog present.

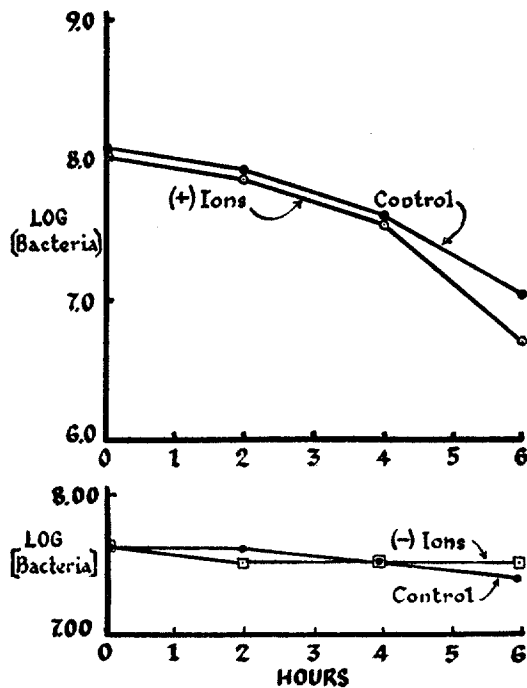

FIG. 11. Absence of air ion effects on survival of staphylococci in 100 lambda drops exposed to atmosphere saturated with water vapor. Po^{210} ionizer $\rightarrow 1 \times 10^8$ ions/cm.²/sec. at 7.5 cm. R.H. 100 per cent; no smog present.

in others. Under these circumstances, neither negative ions nor positive ions exerted any appreciable effect on the rate of cell death (Fig. 11), pH, or Eh (Fig. 12). The significant features of these experiments are (a) The exclusion of air pollutants; (b) the presence in the atmosphere of a large amount of water vapor.

The lack of smog constituents no doubt accounts for the failure of the droplets to display the usual acid shift. Instead of the air ions generated by al-

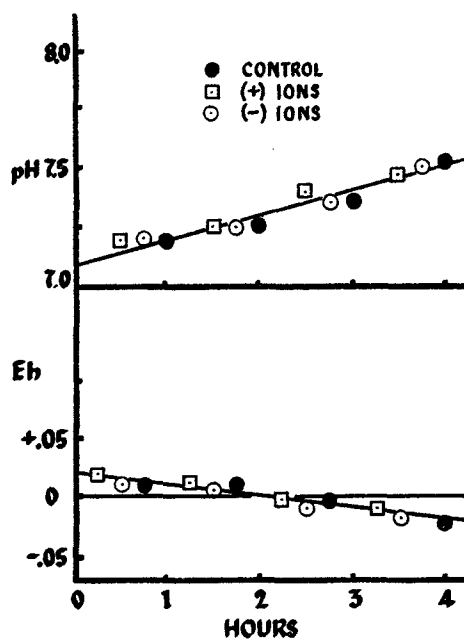

FIG. 12. Absence of acid shift in 100 lambda drops containing staphylococci exposed to atmosphere saturated with water vapor. No smog present.

pha radiation from the Po^{210} acting on soluble substances derived from industrial smoke, they probably encounter water molecules which are known to be easily polarized and the resultant molecular cluster will consist largely of water molecules.

The dependence of air ion effects elicited in these experiments upon the nature of the particular air contaminants present is demonstrated in the results with cigarette smoke. As shown in Fig. 13, moderate concentrations of positive or negative air ions produced by the Po^{210} unit, have little effect upon staphylococci suspended in droplets of distilled water which are permitted to evaporate in a clean atmosphere. However, when air is kept slightly hazy with cigarette smoke, both ions produce an increase in the rate of death (Fig. 14). In such an

atmosphere, the numbers of small ions reaching the surface of the droplet show a sharp drop, for they have the property of attaching themselves to smoke constituents and forming large ions. While the latter are less mobile than small

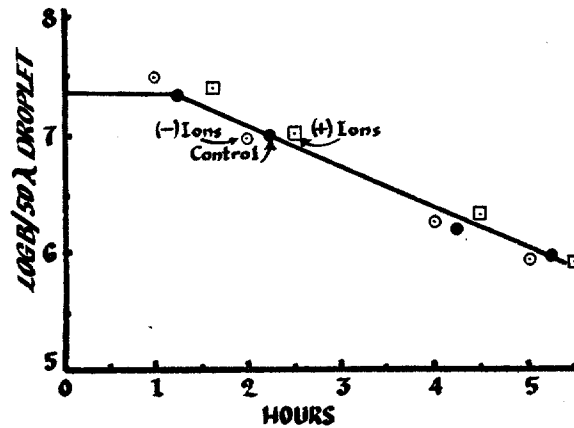

FIG. 13. Absence of air ion effects on staphylococci in 50 lambda evaporating drops. R.H. 36 per cent; no smog present. Po^{210} ionizer $\rightarrow 1 \times 10^8$ ions/cm.²/sec. at 7.5 cm.

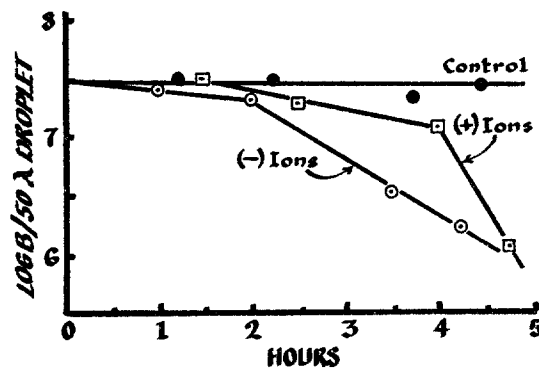

FIG. 14. Lethal effects of air ions on staphylococci in 50 lambda evaporating drops in presence of cigarette smoke. Po^{210} $\rightarrow 1 \times 10^8$ ions/cm.²/sec. R.H. 44 per cent.

ions, it is conceivable that they are toxic and dissolve in the drop of water in sufficient quantities to affect the suspended bacteria. Whatever toxicity they possess would be augmented by the increase in concentration occurring during evaporation of the droplet.

2. *Studies with the Tritium (H^3) Generator.*—The second set of experiments

reported in this paper differs in certain important respects from the first series: (a) H^3 ion generators were used and gave values $> 1 \times 10^9$ ions/cm.²/sec. at the distance employed. In contrast, the Po^{210} generators (set at slightly greater distances) produced only 1×10^8 ions/cm.²/sec. (b) The cells were washed in physiological saline solution. (c) No demonstrable air pollutants were present.

In addition, we found that this type of work could be done with droplets of 50 lambdas or less, so the volumes used in this series were 50 lambdas, 7.6 lambdas, or 3.8 lambdas. Under these circumstances the rate of death of staphylococci suspended in 50 lambda droplets of distilled water was appreciably less than that observed in the earlier experiments and exposure to air ions increased the rate of death in evaporating droplets (Figs. 15*a*, 15*b*, and 15*c*). These same figures indicate the degree of variation observed in consecutive

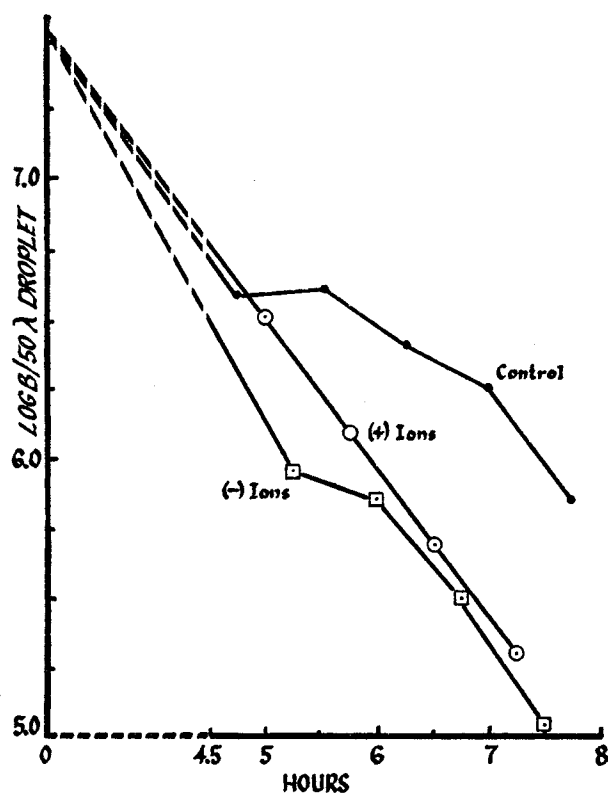

FIG. 15 *a*

FIG. 15*a*, *b*, and *c*. Lethal effects of air ions on staphylococci in 50 lambda evaporating drops. No smog present. H^3 ionizer $\rightarrow 1.6 \times 10^9$ ions/cm.²/sec. at 4 cm. R.H.: Fig. 15 *a*, 91 per cent; Fig. 15 *b*, 48 per cent; Fig. 15 *c*, 47 per cent.

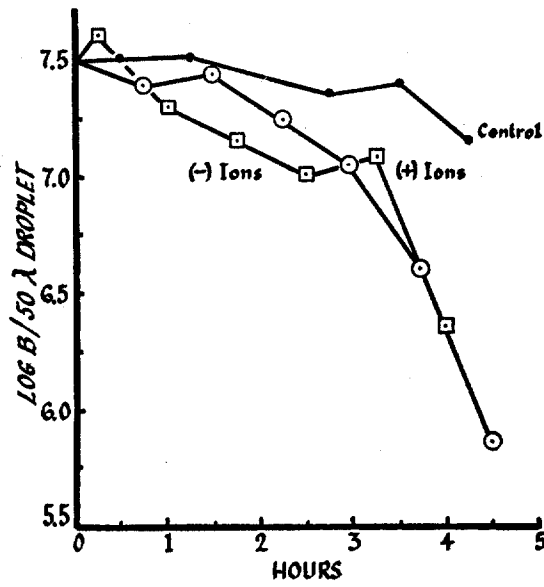

FIG. 15 b

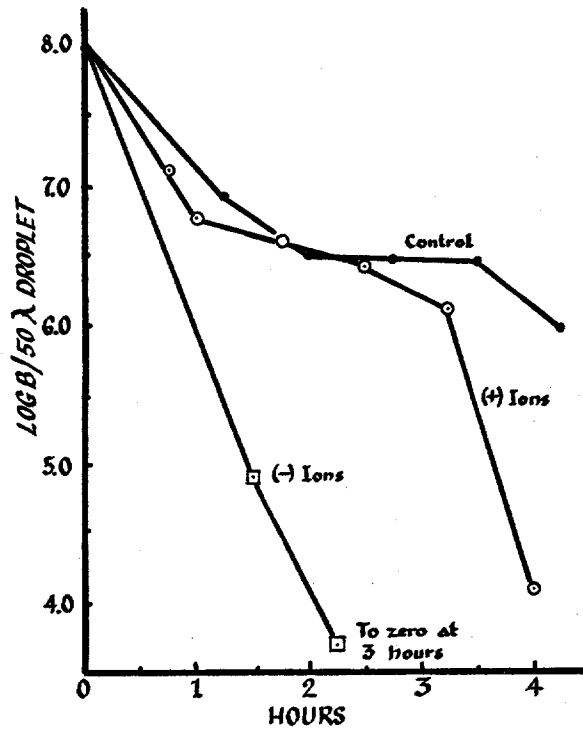

FIG. 15 c

experiments. The downward drift of pH was slow and moderate and there was no significant difference between pH values of the control and ionized droplets.

The rate of evaporation from the droplets was materially increased by air ions (Fig. 16). This seems to be a reasonable consequence of air ion action, for the motion of air ions in a charged field actually constitutes an electrostatic

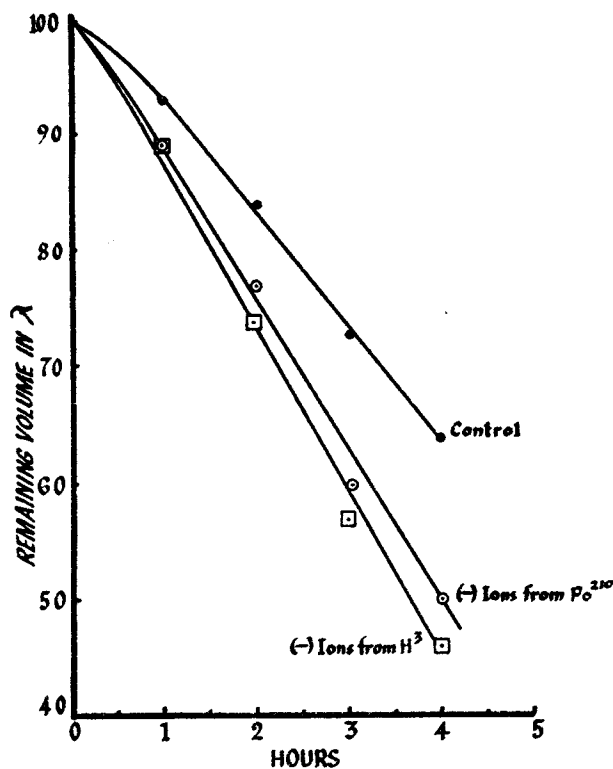

FIG. 16. Increase in rate of evaporation due to air ions acting on 100 lambda drops containing staphylococci. H^3 ionizer $\rightarrow 1.6 \times 10^9$ ions/cm.²/sec. at 4 cm. R.H. 78 per cent; no smog present.

wind and one might expect an increase of kinetic energy of the water molecules present at the air-water interface.

As the distance from the foil to surface of the evaporating droplets was increased from 4 to 8 cm. the effectiveness of the air ions in increasing rate of death was diminished (Fig. 17). At 16 cm. there was no observable difference between the control and ionized preparations (Fig. 18). Measurement of the number of air ions impinging on a given surface area each second indicates the reason for these results: at 4 cm. distance 1.6×10^9 air ions/sec. reached each

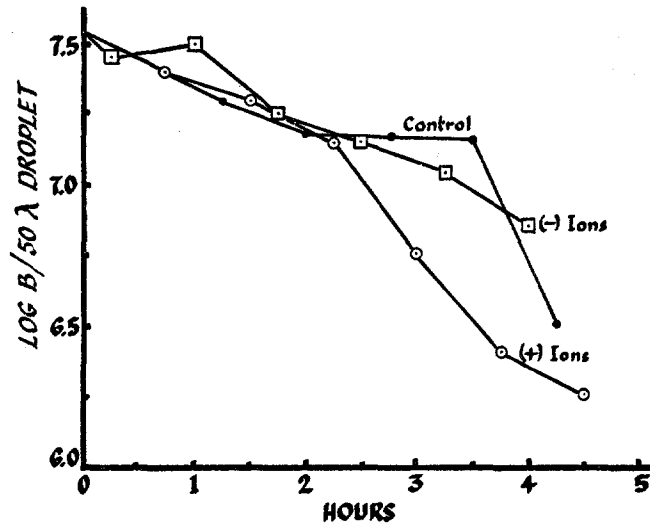

FIG. 17. Reduction of air ion effects with distance. H^3 ionizer $\rightarrow 2.5 \times 10^8$ ions/cm.²/sec. at 8 cm. R.H. 50 per cent; no smog present.

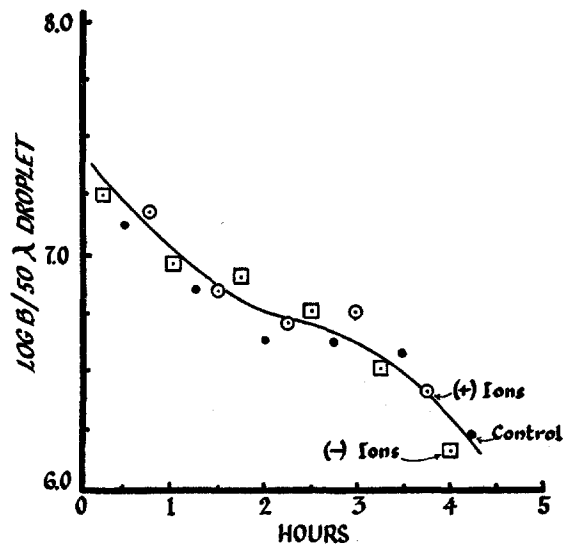

FIG. 18. Absence of air ion effects at 16 cm. H^3 ionizer used $\rightarrow 5 \times 10^6$ air ions/cm.²/sec. at 16 cm. R.H. = 41 per cent; no smog present.

cm². exposed; at 8 cm. the figure becomes approximately 2.5×10^8 air ions/cm.²/sec., and at 16 cm. it is about 5×10^6 air ions/cm.²/sec. (Fig. 19).

Increasing the voltage from ionizer to ground does not enhance the effect of air ions on staphylococci; this is consonant with the air ion yields obtained by varying the voltage of the rectifying circuit (Fig. 20).

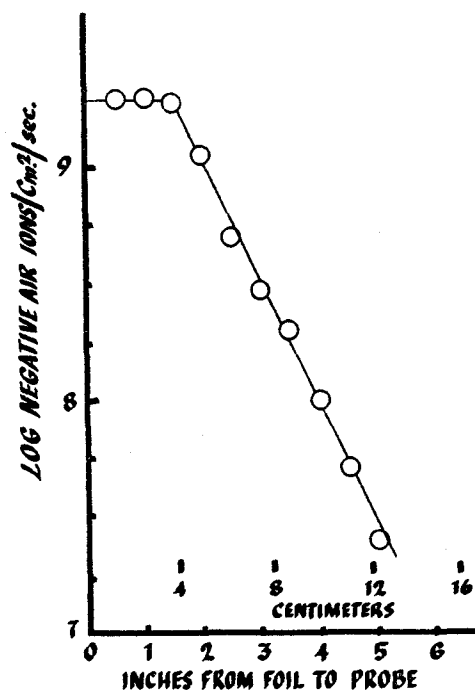

FIG. 19. Variation of rate of air ion impact with distance of ionizer from experimental surface. H³ ionizer used in smog-free air. Measurements made with Beckett probe and Beckman ultrahmeter. R.H. = 47 per cent.

It is important to know whether beta radiation emanating from tritium could act directly on the cocci rather than through the mediation of ions produced in transit through the air. Tritium is a pure beta-emitter with half-life of about 12 years and the energy of irradiation is 0.015 mev. In general the range of beta radiation is independent of the chemical nature of the absorber provided the range is measured as mass of material traversed rather than actual distance. According to Glasser (17) the approximate range for this intensity is *ca.* 0.002 gm./cm². Air has a density of 1.2 mg./ml. Therefore 2×10^{-3} gm./cm.²/1.2 $\times 10^{-3}$ gm./cm³ = 1.7 cm. maximal range. The standard distance of 4 cm. between foil and fluid surface used in our experiments allows a safety factor sufficient to insure that no direct effects of beta radiation play a role.

Po^{210} is an alpha-emitter with a half-life of 140 days and the energy of radiation is approximately 5.3 mev. The maximal range for alpha radiation derived from Po^{210} was calculated to be 3.2 cm. of air (18). The standard experimental distance from foil to water surface was 7.5 cm., allowing an adequate safety factor.

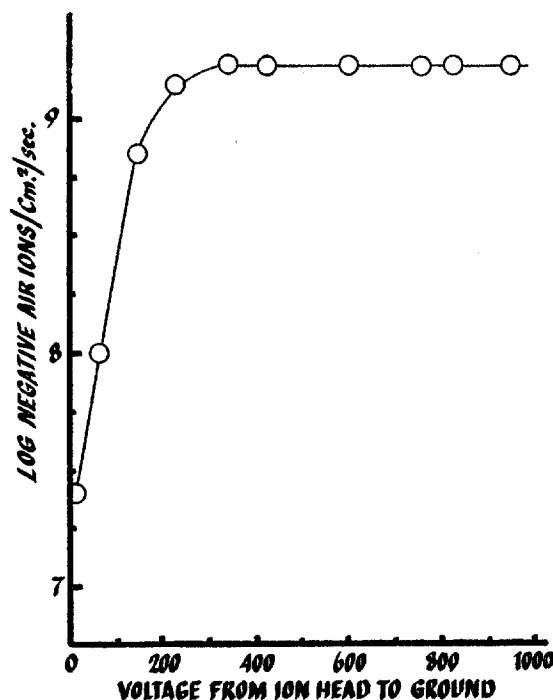

FIG. 20. Variation of rate of air ion impact with voltage of rectifying circuit. H^3 ionizer used in smog-free air. Measurements made with Beckett probe and Beckman ultrahmeter. R.H. = 51 per cent.

Under the conditions prevailing in the H^3 experiments, it would appear that the air ions acted directly on the cells rather than through the mediation of air pollutants, for no pollutants were detected in the atmosphere. If this premise is correct, stirring the droplet should promote the lethal effect. This point was tested by performing a number of experiments in which the total volume of the droplet was kept constant through addition of distilled water at intervals and exposure of the suspended cocci was accomplished by stirring the droplets with fine glass rods mounted in small vibrators. In all these experiments the stirred preparations exhibited considerable increases in the rate of die-away when positive or negative air ions were present (Fig. 21). Stirring did not significantly

affect the stability of the non-ionized controls nor was there any measurable loss of cells ascribable to air ion action in non-stirred controls.

In common with other instances of damage to cells, *e.g.* that caused by ultra-violet light, the effects of treatment with negative air ions are reversed by exposure to intense light of the visible spectrum (Fig. 22).

The H^8 ionizers were also used with plastic canopies within which the atmosphere was maintained at 100 per cent relative humidity in order to main-

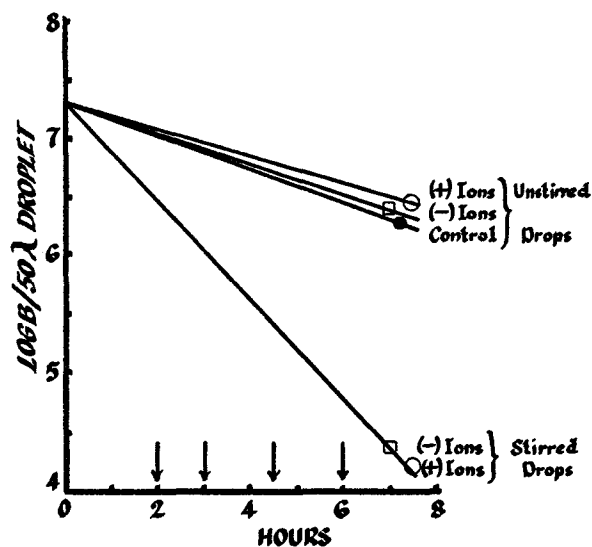

FIG. 21. Effect of stirring on lethal action of air ions on staphylococci in 50 lambda droplets. Volume kept constant by additions of distilled water at times indicated by arrows. H^8 ionizer used $\rightarrow 1.6 \times 10^9$ air ions/cm.²/sec. at 4 cm. R.H. = 40 per cent; no smog present.

tain constant volume of exposed droplets. As might be expected, unstirred 50 lambda droplets containing staphylococci showed no detectable effect of air ions on viability of cells (Fig. 23). On the remote chance that air ion effects at 100 per cent R.H. could be detected by using much smaller droplets we performed a series of experiments with volumes measuring 7.6 lambdas and 3.8 lambdas. Fig. 24 is representative of the results in general and indicates only the accuracy with which viable cell counts can be made on small droplets of cell suspensions; in none of the experiments were there any indications of effects due to air ions.

We have considered the possibility that the effects measured in these experiments might be due to agglomeration of cells. If this were true, any percentage of cells could remain alive and still give the effect of death, for each

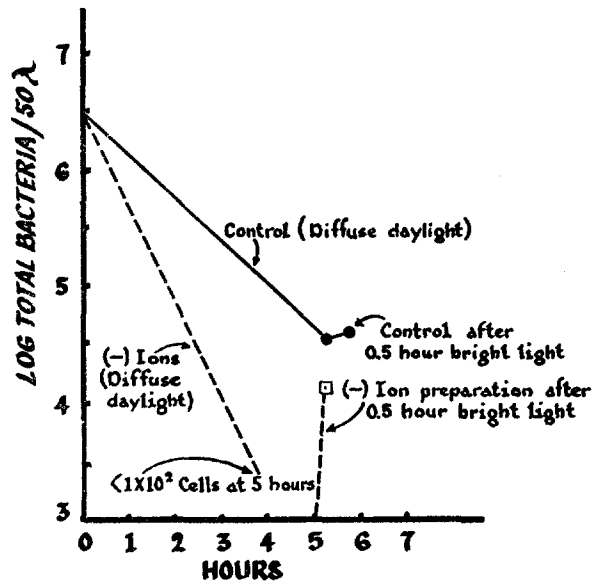

FIG. 22. Photoreactivation of staphylococci after treatment with negative ions. Air ion exposure conducted in diffuse daylight and followed by 0.5 hour exposure to intense visible light. H^2 ionizer used $\rightarrow 1.6 \times 10^9$ air ions/cm.³/sec. at 4 cm.

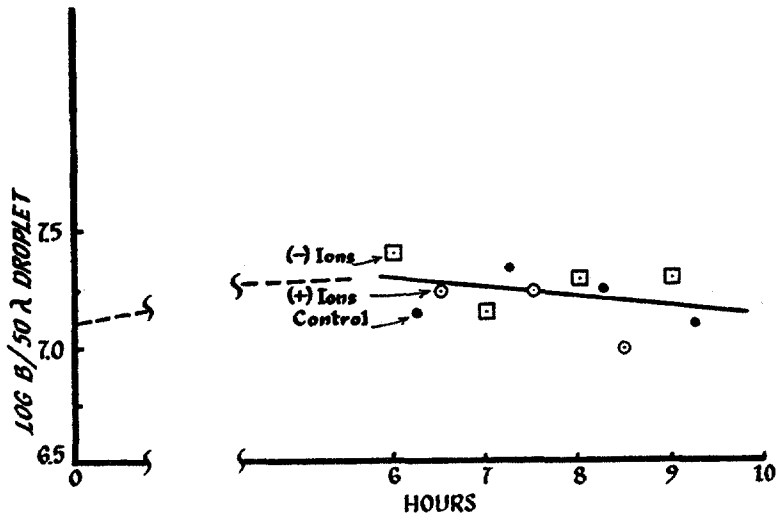

FIG. 23. Absence of action of air ions on unstirred 50 lambda drops of staphylococci maintained in atmosphere saturated with water vapor. H^2 ionizer used; no smog present.

aggregate would produce only one colony and the degree of lethal action simulated would depend merely on the average number of cells in the clusters.

In the tritium experiments, agglutination cannot be invoked to explain the observed results because (a) Microscopic examination of ion-treated droplets reveals no clumps of cells. This is not such convincing evidence as might appear, for often the suspensions employed were not dense and agglutinated cells in numbers sufficient to influence the plate counts could be missed. (b) The lethal

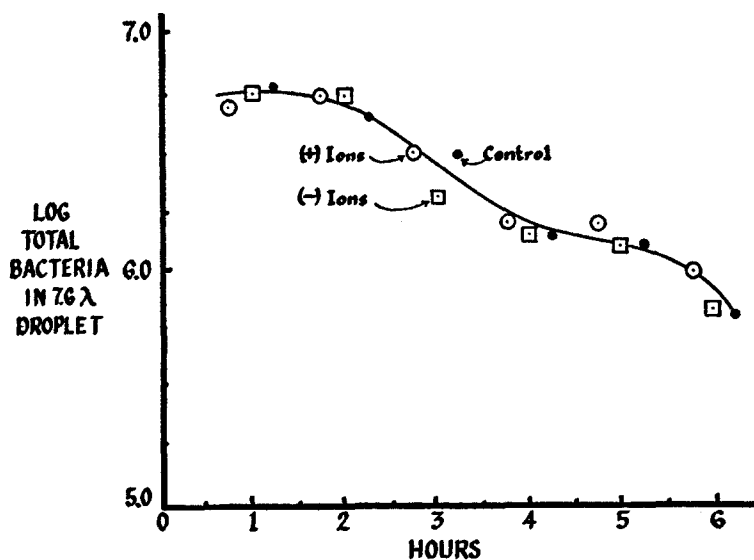

FIG. 24. Absence of action of air ions on unstirred 7.6 lambda drops of staphylococci maintained in atmosphere saturated with water vapor. H^3 ionizer used; no smog present.

effect is reversed by intense light of the visible spectrum; this is typical of many instances of cell damage, *e.g.* that produced by ultraviolet light, but does not occur in cases of simple agglutination. (c) The time periods required to induce the lethal effect in light suspensions are less than the minimal times for agglutination predicted by the von Smoluchowski equation. According to von Smoluchowski (19)

$$t = \frac{1}{4} \pi D^2 r V_0$$

in which t = time in seconds

r = radius of particle

V_0 = number of particles/ml.

and $D = RT/N \cdot 1/6 \pi \eta r$, the Einstein equation for the diffusion coefficient (20).

For the case in question, $t =$ approximately $1.8 \times 10^{11}/V_0$.

When the experiments were performed with light suspensions of cocci, the observed values of t for 90 per cent loss were much less than the calculated minimal times required for agglutination and the observed t 's applied to droplets from which insufficient loss of water by evaporation had occurred to change V_0 significantly.

For example, to obtain a 90 per cent loss by agglutination with $V_0 = 2 \times 10^6$, the calculated minimal elapsed time is 25 hours while the observed time is 1.8 hours. This relationship does not hold for denser suspensions; thus at $V_0 = 5 \times 10^9$, there is no detectable experimental loss after 6 hours of exposure to negative air ions while according to the von Smoluchowski equation, agglutination could occur in as little as 0.1 hour.

Between these extremes of initial cell concentrations, the calculated times agree fairly well with the observed values. But this likely is fortuitous and does not refute the more critical evidence supplied by the lighter cell suspensions.

We wish to express our sincere thanks to W. W. Hicks and J. C. Beckett for their continued interest in this program and for their helpful suggestions.

BIBLIOGRAPHY

1. Wilson, C. T. R., *Proc. Cambridge Phil. Soc.*, 1900, **11**, 32.
2. Elster, J., and Geitel, H., *Physik. Z.*, 1899, **1**, 245.
3. Pollock, J. A., *Phil. Mag.*, 1915, **29**, 514, 636.
4. Dessauer, F., *Zehn Jahre Forschung auf dem Physikalisch Medizinischen Grenzgebiet*, Leipzig, George Thieme, 1931.
5. Skilling, H. H., and Beckett, J. C., *J. Franklin Inst.*, 1953, **256**, 423.
6. Beckett, J. C., and Hicks, W. W., Patent Application Serial #640-434.
7. Kornblueh, I. H., and Griffin, J. E., *Am. J. Physic. Med.* 1955, **34**, 6, 618.
8. Winsor, T., and Beckett, J. C., *Am. J. Physic. Med.*, 1957, in press.
9. Yaglou, C. P., Benjamin, L. C., and Brandt, A. D., *Heating, Piping and Ventilating*, 1933, **5**, 422.
10. Nielsen, C. B., and Harper, H. A., *Proc. Soc. Exp. Biol. and Med.*, 1954, **86**, 753.
11. Worden, J. L., *Fed. Proc.*, 1954, **13**, 168.
12. Worden, J. L., *Science Studies, St. Bonaventure Coll.*, 1953, **5**, 15.
13. Murphy, H. C., *Heating, Piping and Air Conditioning*, 1954.
14. Hicks, W. W., *J. Franklin Inst.*, 1956, **261**, 209.
15. Hicks, W. W., and Beckett, J. C., The Control of Air Ionization and its Biological Effects, Presented before the International Society for the Study of Bioclimatology, Paris, France, Aug. 31, 1956.
16. Chalmers, J. A., *Atmospheric Electricity*, Oxford, Clarendon Press, 1950, 28.
17. Glasser, O., *Medical Physics*, Chicago, Year Book Publishers, Inc., 1944, 644.
18. Lapp, R. E., and Andrews, H. L., *Nuclear Radiation Physics*, New York, Prentice-Hall, Inc., 1948, 166.
19. von Smoluchowski, M., *Physik. Z.*, 1916, **17**, 557, 583.
20. Einstein, A., *Ann. Physik* 1905, **17**, 549.