

Membrane Conductances and Spectral Sensitivities of *Pecten* Photoreceptors

JOHN S. McREYNOLDS and A. L. F. GORMAN

From the Laboratory of Neurophysiology, National Institute of Neurological Diseases and Stroke, National Institutes of Health, Bethesda, Maryland 20014, the Laboratory of Neuropharmacology, Division of Special Mental Health Research, National Institute of Mental Health, St. Elizabeths Hospital, Washington, D. C. 20032, and the Marine Biological Laboratory, Woods Hole, Massachusetts 02543

ABSTRACT The electrical and spectral properties of depolarizing (proximal) and hyperpolarizing (distal) photoreceptors in the eye of the scallop, *Pecten irradians*, were examined. Both depolarizing and hyperpolarizing responses are associated with an increase in membrane conductance; in addition, the depolarizing response is characterized by a secondary decrease in conductance at light intensities which inactivate the response. Both responses can be reversed in polarity by applied current across the cell membrane. The depolarizing response has a reversal potential of approximately +10 mv, whereas the estimated reversal potential for the hyperpolarizing response is near -70 mv. The two responses have the same spectral sensitivity function, which agrees with a Dartnall nomogram for a rhodospin with a λ_{\max} at 500 nm. It is suggested that the photochemical reactions produce different end products which give responses of opposite polarity in proximal and distal cells, or alternatively, that the reactions of the respective cell membranes to the same end product are different.

INTRODUCTION

In the preceding paper (McReynolds and Gorman, 1970) we showed that the retina of the scallop, *Pecten irradians*, contains two types of photoreceptors giving independent responses to light. The microvilli-bearing proximal cells depolarize, whereas the ciliary-type distal cells hyperpolarize upon illumination. It is of interest to determine what properties of these two cell types are responsible for the generation of membrane potential responses of opposite polarity upon illumination. Although many of the steps in the chain leading from absorption of light energy to changes in membrane potential in photoreceptors are not known, it is possible to examine the properties of visual cells at certain stages in the transduction process.

Studies on other light-sensitive neurons suggest two possibilities by which receptor potentials of opposite polarity may be generated. Depolarizing photoreceptors are associated with an increase in membrane conductance during

illumination (Fuortes, 1959; Benolken, 1961; Kikuchi et al., 1962; Brown et al., 1969, 1970; Millecchia and Mauro, 1969) although whether such an increase is causal or secondary has recently been questioned (Smith et al., 1968). Hyperpolarizing receptor potentials have been recorded from vertebrate photoreceptors and are associated with a decrease in membrane conductance (Bortoff and Norton, 1967; Toyoda et al., 1969; Baylor and Fuortes, 1970). From this one might expect to find conductance changes of opposite sign in the proximal and distal cells of *Pecten*. Alternatively, evidence has been presented that opposite membrane responses to light may be caused by different photopigments (Arvanitaki and Chalazonitis, 1949, 1961; Kennedy, 1960; Nolte and Brown, 1969).

The purpose of this paper is to show that neither of these possibilities explains the difference between the proximal and distal cell responses to light, since both the depolarizing and hyperpolarizing responses are associated with an increase in membrane conductance, and both responses have the same spectral sensitivity.

METHODS

The method of preparation and the recording techniques have been described in the preceding paper (McReynolds and Gorman, 1970). The present results were obtained from eyes in which the lens and cornea had been removed, and the argentea left intact. In addition to white light stimuli, monochromatic light (bandwidth, 9.6 nm) of any desired wavelength between 350–700 nm was used. Light from a 45 w tungsten quartz-iodine lamp passed through a grating monochromator, electrically operated shutter, calibrated neutral density filters, and a field aperture. A photocell monitored the monochromatic stimulus at a point beyond the shutter. The output of the monochromator at each wavelength was measured with a radiometer, and sensitivity measurements were corrected for the differences in energy at different wavelengths.

Spectral sensitivities of single cells were determined in dark-adapted eyes by measuring the intensity of a 100 msec flash required to evoke a criterion response of 10 mv at each wavelength. Responses were measured at 10 or 25 nm intervals, at wavelengths from 350–700 nm. Control responses to a flash of a given wavelength were measured at various times during the experiment to check that the response was not changing in sensitivity with time.

Because it was difficult to hold most units for a sufficient length of time to measure spectral sensitivities by this method, the required information was obtained more quickly in some experiments by simply determining the V -log I relation at different wavelengths from 350–700 nm. Responses were measured at each wavelength to flashes of increasing intensity, but intensity was not increased to the point at which the responses began to adapt. Since the V -log I relationships for different wavelengths were parallel, the spectral sensitivity was determined from these curves by measuring the stimulus intensity corresponding to a constant amplitude of response at each wavelength.

With either method, the measured light intensity for obtaining a constant response

at each wavelength was corrected for the actual flux output of the monochromator, converted to quanta, and the reciprocal of this value plotted as the sensitivity.

RESULTS

Conductance Changes during Illumination

Membrane conductance during darkness and illumination was studied by passing short hyperpolarizing constant current pulses through the recording electrode and measuring the voltage drop across the membrane (ΔV). As evidenced by the changes in amplitude and time course of ΔV (Fig. 1 A and B), membrane conductance increased during both the peak and steady state of the hyperpolarizing response to light, and often persisted for a short time after the end of the light stimulus. The greatest change was associated with the peak of the response; with the brightest light flashes ΔV could fall to less than

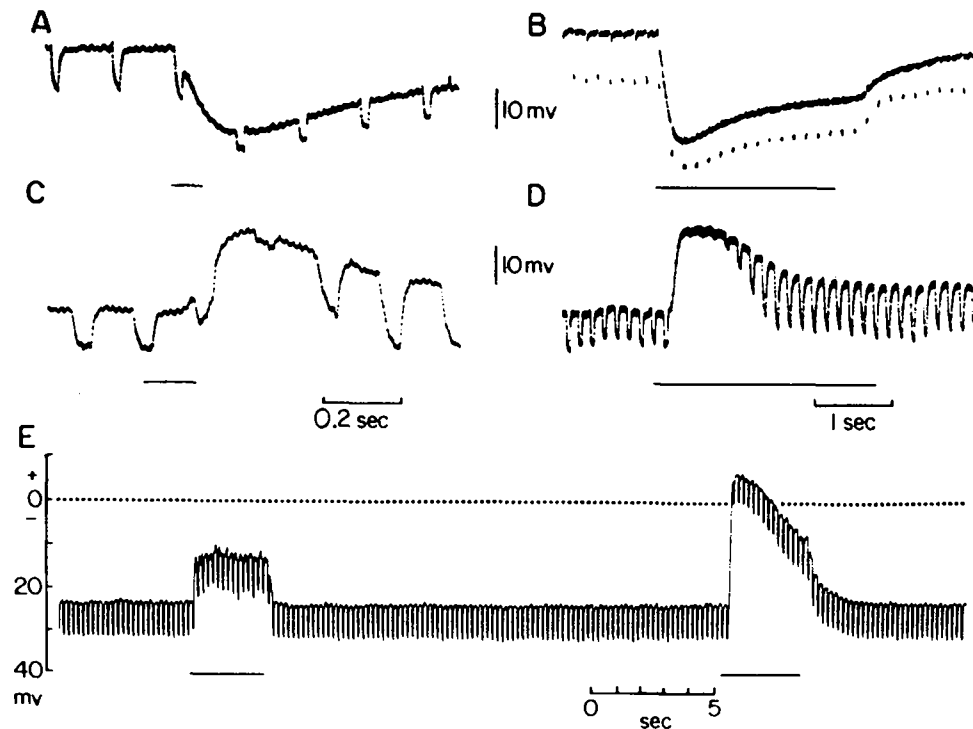

FIGURE 1. Conductance changes during depolarizing and hyperpolarizing responses to light. The membrane responses to constant current pulses are shown before, during, and after illumination. Records are from five different cells. Duration of light stimulus indicated by horizontal line under each response. Light intensities: $\text{Log } I = -2.4$ in A; -1.2 in B and C; 0 in D; -4.2 and -3.6 in E. Time calibration 0.2 sec for A and C, 1 sec for B and D, 5 sec for E. Dashed line in E indicates zero membrane potential.

10% of its value in the dark. During the steady-state portion of a hyperpolarizing response to full intensity light, ΔV was reduced to about 50% of its dark height. With less intense stimuli the conductance increase was less. A second, transient increase in conductance was sometimes seen following the end of the stimulus (Fig. 1 B). These findings confirm those of Toyoda and Shapley (1967) and clearly show that the light-evoked hyperpolarization of the distal cells differs from the response of vertebrate photoreceptors to light, where the hyperpolarization is associated with a decrease, rather than increase, in membrane conductance (Bortoff and Norton, 1967; Toyoda et al., 1969; Baylor and Fuortes, 1970).

The conductance changes associated with the depolarizing response were more complex, involving both an increase and a decrease. Fig. 1 E shows the response of a depolarizing unit to different intensities of light. The depolarization caused by a dim light ($\log I = -4.2$) was not accompanied by any detectable conductance change, but a moderately bright light ($\log I = -3.6$) which caused a larger response produced a definite increase in conductance. At higher intensities (Fig. 1 C and D) a large increase in conductance occurred during the peak of the depolarizing response, followed by a decrease in conductance to a lower value than before the flash. This delayed decrease in conductance was a consistent finding at intensities which caused marked desensitization of depolarizing cells (McReynolds and Gorman, 1970), and occurred whether the flash was brief (Fig. 1 C) or prolonged (Fig. 1 D).

The changes in conductance associated with light-evoked responses could be misleading if the membrane conductance were voltage dependent (Smith et al., 1968). It is therefore important to examine the current-voltage characteristics of both proximal and distal cells for nonlinearities. Constant current steps of various intensities were passed across the cell membrane and the steady-state potential was measured 1 sec after the beginning of the current step (see insets, Fig. 2). Figs. 2 and 4 show that the current-voltage relations of both proximal and distal cells are reasonably linear over the range of potentials evoked by light.

Table I provides a comparison of membrane constants for eight proximal and eight distal cells, obtained from data similar to those shown in Fig. 2. As might be expected for such small cells the input resistance values are high. The average membrane potential and input resistance of the proximal cells were lower than those for the distal cells.

Membrane charging transients obtained with small hyperpolarizing and depolarizing currents were reasonably linear when plotted logarithmically as a function of time (Fig. 3) for both cell types. The time constants calculated from these plots were approximately 5 msec. The simple exponential time course of the membrane transient suggests that the contribution of the axon to the total input resistance of the proximal and distal cells may be relatively small.

Reversal Potentials

If the increase in conductance of the proximal and distal cells during illumination represents a change in membrane permeability to one or more ions, then it should be possible to define reversal potentials (i.e., the potential

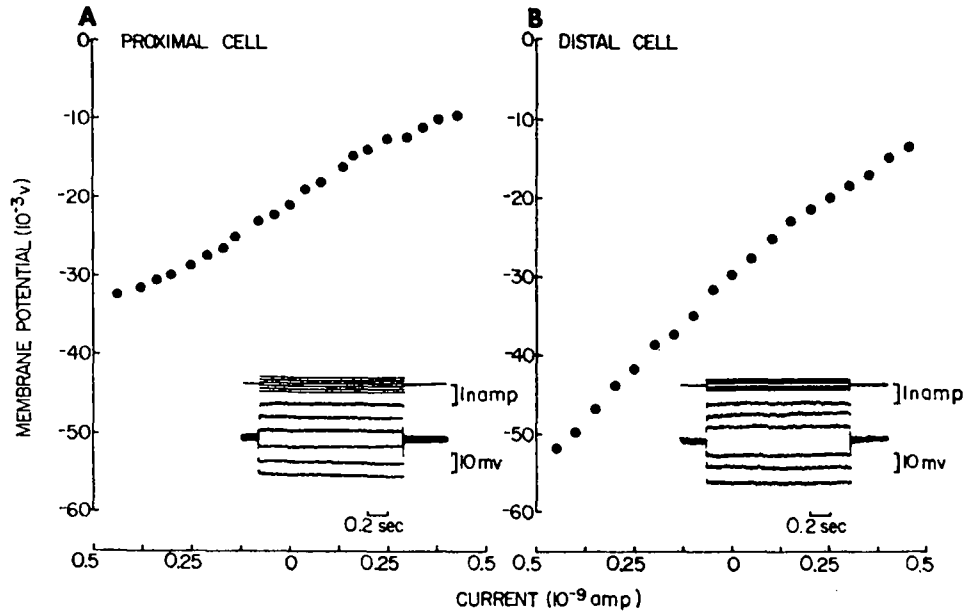

FIGURE 2. Current-voltage relations of proximal and distal cells. Points indicate steady potential measured 1 sec after onset of constant current pulse. Insets show potential changes (below) produced by different current steps (above). A, proximal cell; B, distal cell. Responses shown in the insets are from different cells than data shown in plots.

TABLE I
MEMBRANE CONSTANTS

	Distal cell		Proximal cell	
	Membrane potential	Input resistance	Membrane potential	Input resistance
	$10^{-4} V$	$10^6 \Omega$	$10^{-4} V$	$10^6 \Omega$
1	40	90	1	25
2	38	75	2	25
3	35	60	3	70
4	34	140	4	50
5	29	50	5	30
6	26	25	6	55
7	20	42	7	95
8	18	60	8	30
Mean \pm SEM	30 ± 2.9	67.8 ± 12.4	23.0 ± 1.7	47.5 ± 8.9

at which the response reverses polarity) for these responses by displacing the membrane potential with applied currents. The rectification and instability of the electrodes with current intensities greater than 10^{-9} amp, however, made it difficult to reverse the polarity of the receptor potentials in most cells. Although estimated reversal potentials could be calculated in many cells, actual reversal of the response was possible in only four units. Fig. 4 illustrates the effect of displacing the membrane potential to various steady levels on the peak

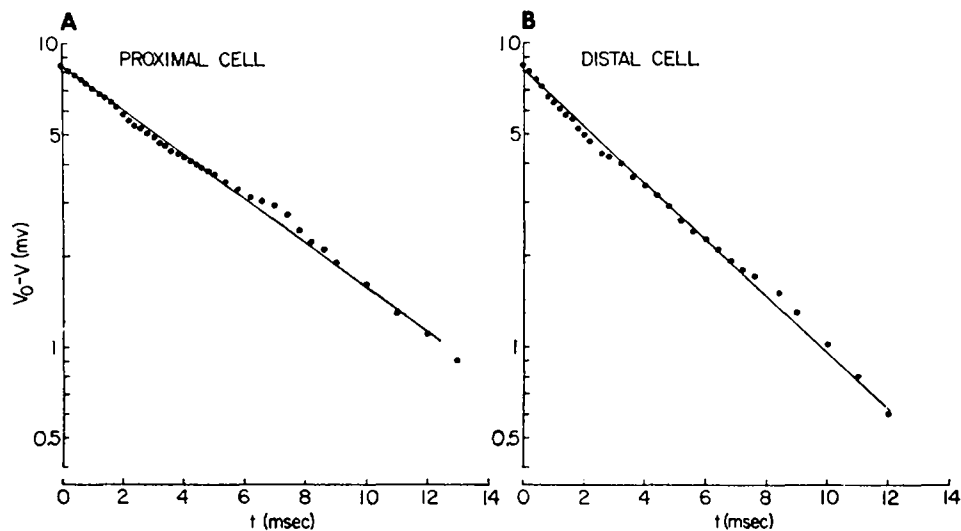

FIGURE 3. Logarithmic plot of proximal and distal cell transient response to a hyperpolarizing current step. The ordinate represents the quantity $V_0 - V$, where V_0 is the membrane potential at the end of the response and V is the level of the potential at time t . The abscissa represents the time from the onset of the applied current. The straight lines drawn through the points show the exponential time course of the responses. In A, time constant 6.2 msec; B, time constant 5.1 msec.

response to a constant light flash. Moderate intensity (-3.9) test flashes were used for proximal cells in order to avoid the adaptation and the delayed conductance decrease associated with bright flashes. The open circles show the steady membrane potential in the dark at various intensities of applied current. At each level of membrane potential a constant light flash was given, and the potential reached at the peak of the response is indicated by the filled circles. The measured reversal potential was more positive than zero potential in proximal cells ($+7$ mv in Fig. 4 A and $+11$ mv in another unit). The true reversal potential for the depolarizing response may be more positive than this, since these particular cells had lower resting potentials and smaller responses to light than many others. Also, other proximal cells showed responses to light which reached a maximum potential of up to 20 mv inside positive.

In distal cells the hyperpolarizing response to a constant light flash de-

creased linearly with increasing membrane potential levels, and gave estimated reversal potentials of -71 to -73 mv (Fig. 4 B). The hyperpolarizing receptor potential could be reversed (inset, Fig. 4 B) but only by passing such large currents that it was impossible to maintain bridge balance and monitor the absolute value of membrane potential.

The increase in membrane conductance during the peak response to moderate intensity light flashes, estimated from the difference in slopes of the cur-

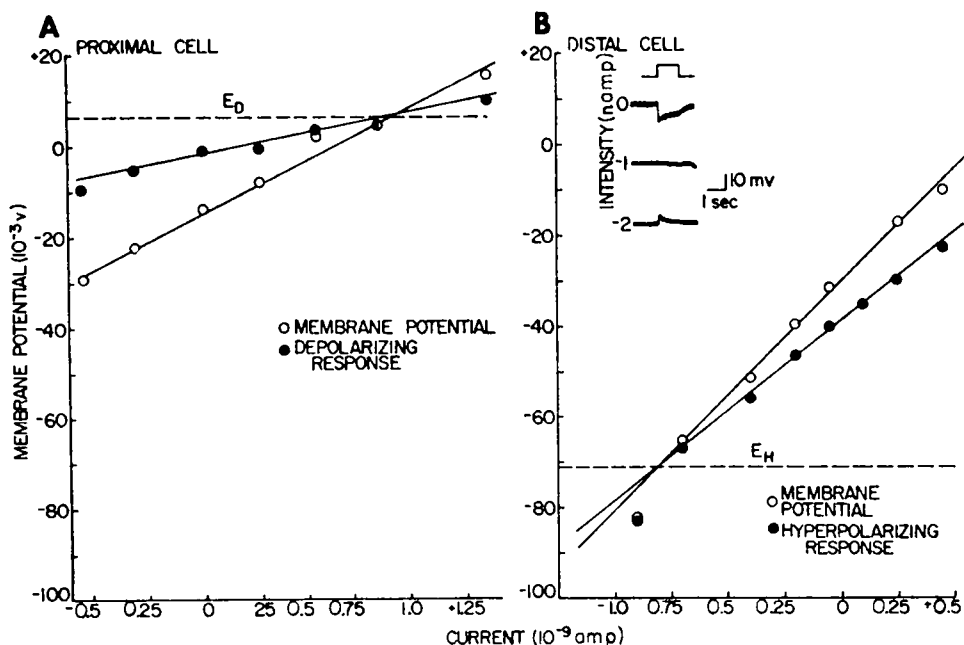

FIGURE 4. Reversal potentials of depolarizing and hyperpolarizing responses. A, proximal cell; B, distal cell. Open circles, membrane potential in dark. Filled circles, peak potential reached by response to constant 100 msec light flash. Dashed lines indicate equilibrium potentials for proximal (E_D) and distal (E_H) cell response. Inset in B, reversal of hyperpolarizing receptor potential with large negative current. Light flash monitor above top response.

rent-voltage plots in light and dark (Fig. 4), was approximately 45% in proximal cells and 30% in distal cells. These values are in reasonable agreement with the changes in amplitude of the potential drop produced by brief constant current pulses during the peak response to light flashes of similar intensity.

Spectral Sensitivities of Proximal and Distal Cells

The responses of a depolarizing unit to light flashes at two widely separated wavelengths could be matched in amplitude by adjusting the intensity of the light (Fig. 5 A). For the same two wavelengths, the same ratio of stimulus

intensities also produced responses of equal amplitude in a hyperpolarizing unit (Fig. 5 B), suggesting that both types of responses are due to the same photopigment. Furthermore, whenever responses of a given cell were matched in amplitude at two wavelengths the responses were also identical in shape, indicating that a single photochemical process is involved at all wavelengths. Only six intracellular units (three proximal and three distal) could be held long enough, and without any change in sensitivity, to obtain complete spectral sensitivity curves. The results from a depolarizing and a hyperpolarizing cell are shown in Fig. 6 A. Both cell types showed a maximum sensitivity at

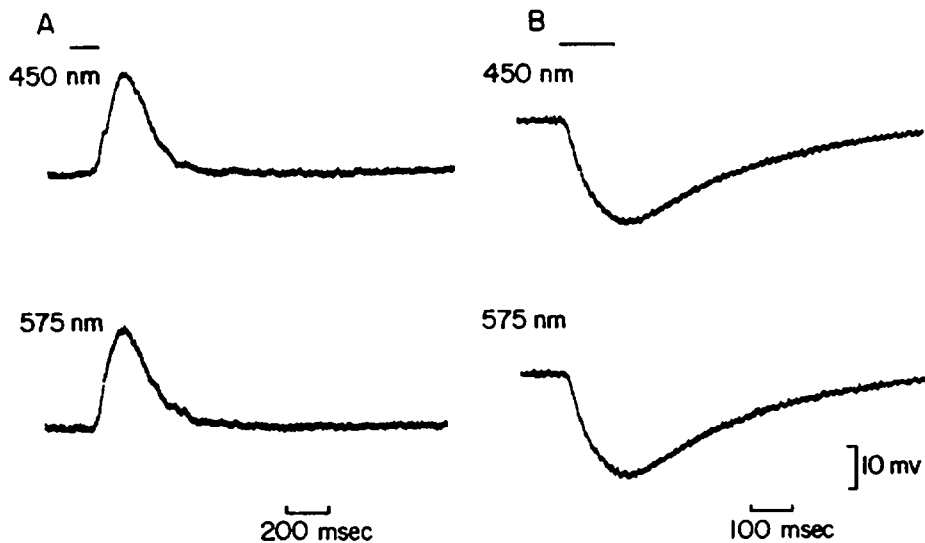

FIGURE 5. Matched hyperpolarizing and depolarizing responses at different wavelengths of stimulating light. A, proximal cell. Response at 450 nm is matched by response to 0.7 log unit brighter stimulus at 575 nm. B, distal cell. Response at 450 nm is matched by response to 0.6 log unit brighter stimulus at 575 nm.

500 nm, but the hyperpolarizing cells were approximately 2 log units less sensitive than the depolarizing cells, reflecting the typical difference in sensitivity of the two types to white light (McReynolds and Gorman, 1970).

If the hyperpolarizing spectral sensitivity curve of Fig. 6 A is shifted upward it coincides with that of the depolarizing response and the measured spectral sensitivity functions for proximal and distal cells show a good fit to a Dartnall nomogram curve (Dartnall, 1953) for the theoretical absorption of a visual pigment with $\lambda_{\max} = 500$ nm (Fig. 6 B). The other cells from which complete curves were obtained also had their peak sensitivity at 500 nm. These results suggest that both the hyperpolarizing and depolarizing responses are due to the same visual pigment.

Our results are in good agreement with the spectral sensitivity determined

from the electroretinogram (ERG) in *Pecten irradians* (Fig. 7) by Wald and Seldin (1968). They found that all the components of the ERG had the same spectral sensitivity, although none of these components has been definitely identified with either proximal or distal cell activity (Wald and Seldin, per-

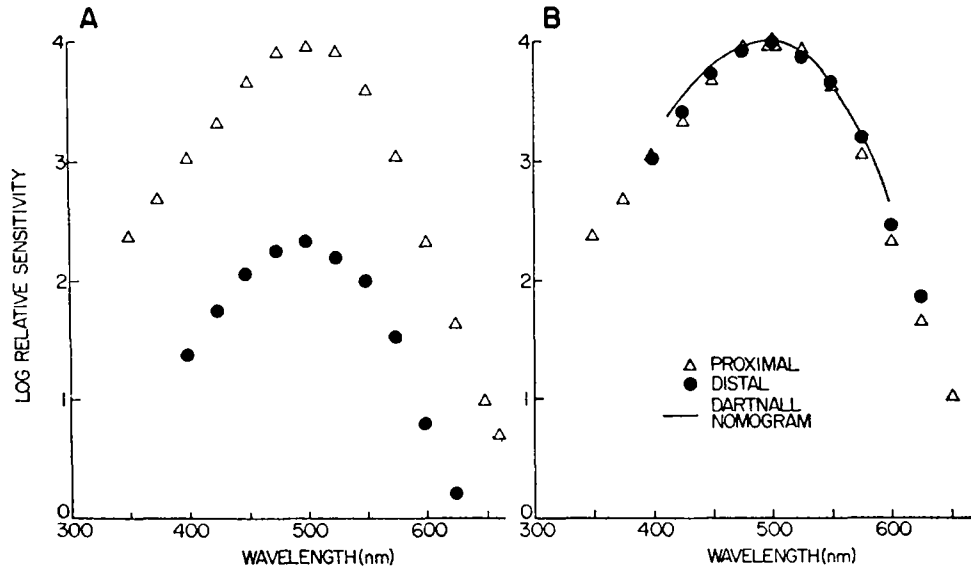

FIGURE 6. Spectral sensitivities of proximal and distal cells. In B the curve from the distal cell shown in A was shifted upward by 1.7 log unit. A Dartnall nomogram curve for a pigment with a $\lambda_{max} = 500$ nm is shown in B.

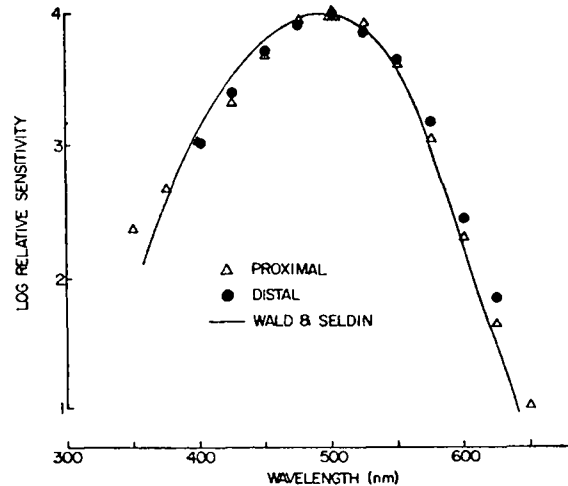

FIGURE 7. Comparison of spectral sensitivities of proximal and distal cells to ERG. Same experimental points as shown in Fig. 6 B. Curve represents ERG spectral sensitivity function kindly provided by G. Wald and E. Seldin (unpublished).

sonal communication). However, since our results indicate that both cell types have the same visual pigment, their much more extensive data provide good support for the accuracy of the curves we have obtained.

DISCUSSION

Although in previously studied photoreceptors depolarizing responses are associated with an increase in membrane conductance and hyperpolarizing responses with a decrease in conductance, this difference does not account for the opposite polarity of receptor potentials in the retina of *Pecten*. Both the depolarizing and hyperpolarizing receptor potentials are associated with an increase in membrane conductance. There are two reasons for assuming that these changes in conductance are the cause of the receptor potentials. The linearity of the current-voltage relations in both proximal and distal cells, and the decrease in slope of these relations during illumination, indicate that membrane conductance is light-dependent but not voltage-dependent. Second, the receptor potentials have clear and quite different reversal potentials, a finding which is difficult to explain unless changes in membrane permeability to different ions underlie the two responses.

The peak of the depolarizing receptor potential, as well as the reversal potential for this response, was more positive than the zero membrane potential. These findings suggest that the equivalent circuit for the proximal cell is similar to that for other depolarizing receptor potentials (Fuortes, 1959; Rushton, 1959), but with an inside positive emf in series with the conductance controlled by light (Fig. 8 A). In contrast, the hyperpolarizing receptor potential peak reaches membrane potentials as large as -70 mv and its reversal potential was slightly more negative than this value. The equivalent circuit for the distal cell therefore must have an inside negative emf in the light-sensitive branch of the circuit, with a value more negative than that controlling resting membrane potential (Fig. 8 A). This circuit is similar to the one developed for the inhibitory postsynaptic potential in motoneurons (Coombs et al., 1955) rather than to the circuit proposed for hyperpolarizing photoreceptors in the vertebrate retina (Baylor and Fuortes, 1970). A decrease in conductance during hyperpolarizing responses to light may be peculiar to vertebrate photoreceptors. So far such measurements have not been performed on any hyperpolarizing photoreceptors in invertebrates other than *Pecten*.

Nothing is known about the particular ions involved in either response in the *Pecten* retina; it is possible that more than one ionic species contributes to each emf. The equivalent circuits shown in Fig. 8 A provide a convenient but probably overly simplified model for proximal and distal receptor potentials. For example, to account for the delayed decrease in conductance in proximal cells following stimulation with high light intensities it must be assumed that E_D and g_D represent the concentration gradients and permeabilities of more

than one ion. In this way, the sequence of conductance changes associated with the depolarizing receptor potential may be ascribed to changes in the relative permeability of the membrane to these ions as a function of time and light intensity.

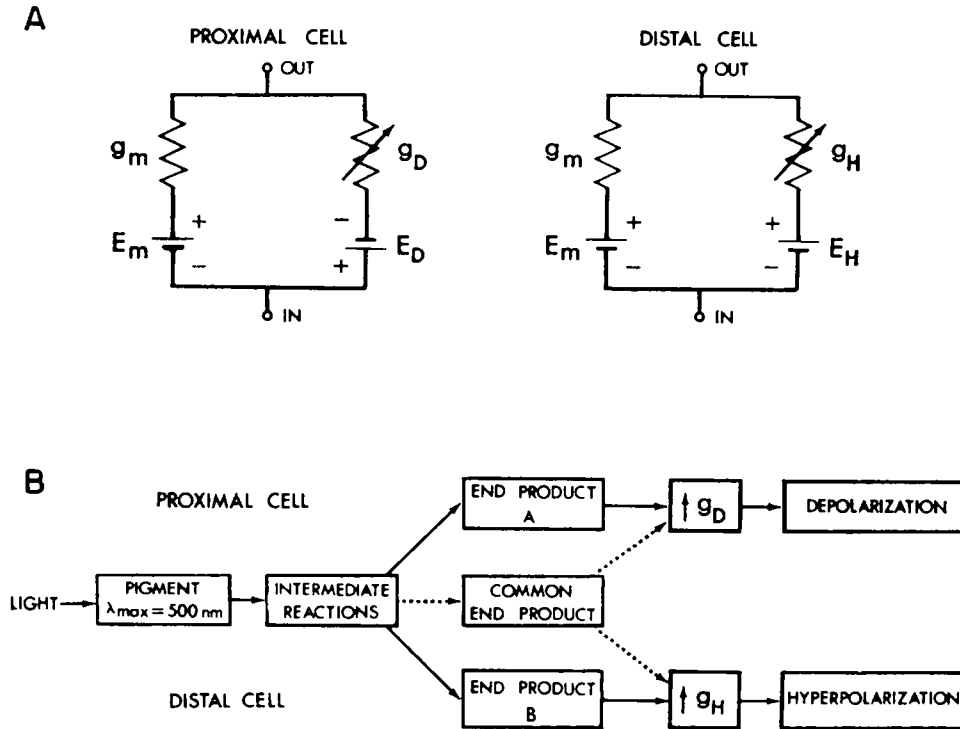

FIGURE 8. A, equivalent circuits for proximal and distal cell membranes. OUT denotes outside and IN inside of cell membrane. The membrane in both cells is represented by a battery E_m in series with a fixed conductance g_m . In parallel with this branch the proximal cell has an inside positive battery E_D in series with a conductance g_D whose value is increased by light. In the distal cell this branch has an inside negative battery E_H , whose value is greater than E_m , in series with a conductance g_H whose value is increased by light. B, diagram showing two possible ways in which absorption of light by the same photopigment could produce responses of opposite polarity in proximal and distal cells. Vertical arrows in front of g_D and g_H indicate increases in these conductances.

The spectral sensitivity function for both the hyperpolarizing and depolarizing responses has a peak at approximately 500 nm, and coincides with Dartnall's (1953) nomogram for a rhodopsin with peak absorption at that wavelength. These spectral sensitivity functions may be affected slightly by the presence of the reflecting argentea (Land, 1966 *b*), but both cell types should be equally affected. The spectral sensitivity of a behavioral "off" response in *Pecten maximus*, however, has two components, with a major peak at 475 nm

and a minor peak at 540 nm (Cronly-Dillon, 1966). To what extent this difference is due to other factors, such as the species difference or the contribution of other photoreceptors to the behavioral response, is not clear since the spectral sensitivity of the "off" discharge in *Pecten irradians* has not been measured.

It is apparent from previous studies (Hartline, 1938; Land, 1966 *a*) that light has two distinct effects on the distal cell: inhibition of impulses, and a buildup of excitability which is reflected in the subsequent "off" discharge. We have shown that the inhibition of firing during illumination is due to a hyperpolarizing receptor potential, and have considered the possibility that the "off" response may be a membrane phenomenon consequent to the primary hyperpolarization (McReynolds and Gorman, 1970). In some other lamelli-branch molluscs (Kennedy, 1960; Mpitsos, 1969) there is evidence that two photopigments are involved in generation of the "off" response. Kennedy (1960) proposed that different photopigments produce separate excitatory and inhibitory effects, with different time courses, which interact to produce the inhibition and subsequent "off" discharge. Although we measured the spectral sensitivity of only the inhibitory, hyperpolarizing response in distal cells, the amplitude matched responses were identical in shape throughout the spectrum and revealed no evidence of an opposing process at any wavelength. Furthermore, the spectral sensitivity of the ERG in *Pecten irradians* shows no change in shape with red or violet chromatic adaptation sufficient to reduce the over-all sensitivity by 2 log units (Wald and Seldin, personal communication). While we cannot exclude the possibility that the "off" discharge in *Pecten* is somehow due to a second pigment, it is not apparent in the receptor potential responses we have recorded.

It is interesting that the same spectral sensitivity function is associated not only with receptor potentials of opposite polarity, but also with greatly different sensitivities to light intensity. Unlike vertebrate rods and cones, the difference in sensitivity of the proximal and distal photoreceptors in *Pecten* is not associated with any difference in the spectral response.

The findings of Arvanitaki and Chalazonitis (1949, 1961) and Nolte and Brown (1969) that different photosensitive pigments produced membrane changes of opposite polarity, and the work of Kennedy (1960), suggest that differences in sign of the response of visual receptor cells might be directly related to differences in their photopigments. In *Pecten*, however, the same visual pigment appears to be responsible for the depolarizing response of the proximal cells and the hyperpolarizing response of the distal cells. It is possible that two visual pigments, although spectrally similar, could differ in some aspect of their molecular structure which might be responsible for the different response characteristics. Although the link between photopigment excitation and the reaction of the cell membrane remains unclear (Wald et al., 1963;

Hagins, 1965), it has become apparent in recent years that the transduction process probably involves a chain of chemical reactions whose end product is capable of altering the properties of the cell membrane (Fuortes and Hodgkin, 1964; Wald, 1965; Borsellino et al., 1965; DeVoe, 1967). Moreover, it is likely that the processes leading to the receptor potential occur within or near the photoreceptive portion of the membrane (Wald et al., 1963; Hagins, 1965; Borsellino and Fuortes, 1968; Lasansky and Fuortes, 1969), and that the photopigment molecules may be contained in this part of the cell membrane (Wald et al., 1963; Smith and Brown, 1966; Hagins and McGaughy 1968).

At least two possibilities (Fig. 8 B) are available to explain how a series of intermediate chemical reactions initiated by changes in the same photopigment molecule can produce opposite effects on the membrane. Differences in the intermediate reactions in proximal and distal cells could lead to the production of different end products, acting like separate excitatory and inhibitory transmitter agents (Fatt and Katz, 1953; Eccles, 1964). Alternatively, by analogy to the excitatory and inhibitory reactions of different molluscan neurons to the same chemical agent (Tauc and Gerschenfeld, 1961; Kandel, 1967) the responses of the proximal and distal cells to the same photochemical end product could be different. For example, opposite responses to the same substance might be due to its opening of different ionic channels (Chiarandini and Gerschenfeld, 1967; Chiarandini et al., 1967) in the proximal and distal cells.

Received for publication 9 March 1970.

REFERENCES

- ARVANITAKI, A., and N. CHALAZONITIS. 1949. Inhibition ou excitation des potentielles neuro-nique a la photoactivation distincte de deux chromoproteides (carotenode et chlorophyllien). *Arch. Sci. Physiol.* 3:45.
- ARVANITAKI, A., and N. CHALAZONITIS. 1961. Excitatory and inhibitory processes initiated by light and infra-red radiations in single identifiable nerve cells. In *Nervous Inhibition*. E. Florey, editor. Pergamon Press, New York. 194.
- BAYLOR, D. A., and M. G. F. FUORTES. 1970. Electrical responses of single cones in the retina of the turtle. *J. Physiol. (London)*. 207:77.
- BENOLKEN, R. M. 1961. Reversal of photoreceptor polarity recorded during the graded receptor potential response to light in the eye of *Limulus*. *Biophys. J.* 1:551.
- BORSELLINO, A. I., and M. G. F. FUORTES. 1968. Interpretation of responses of visual cells of *Limulus*. *Proc. Inst. Elec. Eng.* 56:1024.
- BORSELLINO, A. I., M. G. F. FUORTES, and T. G. SMITH. 1965. Visual responses in *Limulus*. *Cold Spring Harbor Symp. Quant. Biol.* 30:429.
- BORTOFF, A., and A. L. NORTON. 1967. An electrical model of the vertebrate photoreceptor cell. *Vision Res.* 7:253.
- BROWN, H. M., S. HAGIWARA, H. KOIKE, and R. W. MEECH. 1970. Membrane properties of a barnacle photoreceptor examined by the voltage clamp technique. *J. Physiol. (London)*. 208:385.
- BROWN, H. M., R. W. MEECH, H. KOIKE, and S. HAGIWARA. 1969. Current-voltage regulations during illumination: photoreceptor membrane of a barnacle. *Science (Washington)*. 166:240.

- CHIARANDINI, D. J., and H. M. GERSCHENFELD. 1967. Ionic mechanism of cholinergic inhibition in molluscan neurons. *Science (Washington)*. **156**:1595.
- CHIARANDINI, D. J., E. STEFANI, and H. M. GERSCHENFELD. 1967. Ionic mechanisms of cholinergic excitation in molluscan neurons. *Science (Washington)*. **156**:1597.
- COOMBS, J. S., J. C. ECCLES, and P. FATT. 1955. The specific ionic conductances and the ionic movements across the neuronal membrane that produce the inhibitory postsynaptic potential. *J. Physiol. (London)*. **130**:326.
- CRONLY-DILLON, J. R. 1966. Spectral sensitivity of the scallop *Pecten maximus*. *Science (Washington)*. **151**:345.
- DARTNALL, H. J. A. 1953. The interpretation of spectral sensitivity curves. *Brit. Med. Bull.* **9**:24.
- DEVOE, R. D. 1967. A nonlinear model for transient responses from light-adapted wolf spider eyes. *J. Gen. Physiol.* **50**:1993.
- ECCLES, J. C. 1964. *The Physiology of Synapses*. Springer-Verlag, Berlin.
- FATT, P., and B. KATZ. 1953. The effect of inhibitory nerve impulses on a crustacean muscle fibre. *J. Physiol. (London)*. **121**:374.
- FUORTES, M. G. F. 1959. Initiation of impulses in visual cells of *Limulus*. *J. Physiol. (London)*. **148**: 14.
- FUORTES, M. G. F., and A. L. HODGKIN. 1964. Changes in time scale and sensitivity in the ommatidia of *Limulus*. *J. Physiol. (London)*. **172**:239.
- HAGINS, W. A. 1965. Electrical signs of information flow in photoreceptors. *Cold Spring Harbor Symp. Quant. Biol.* **30**:403.
- HAGINS, W. A., and R. E. MCGAUGHY. 1968. Membrane origin of the fast photovoltage of squid retina. *Science (Washington)*. **159**:213.
- HARTLINE, H. K. 1938. The discharge of impulses in the optic nerve of *Pecten* in response to illumination of the eye. *J. Cell. Comp. Physiol.* **11**:465.
- KANDEL, E. R. 1967. Dale's principle and the functional specificity of neurons. In *Electrophysiological Studies in Neuropharmacology*. W. Koelle, editor. C. C Thomas Publisher, Springfield, Ill. 385.
- KENNEDY, D. 1960. Neural photoreception in a lamellibranch mollusc. *J. Gen. Physiol.* **44**:277.
- KIKUCHI, R., K. NAITO, and I. TANAKA. 1962. Effect of sodium and potassium ions on the electrical activity of single cells in the lateral eye of the horseshoe crab. *J. Physiol. (London)*. **161**:319.
- LAND, M. F. 1966 *a*. Activity in the optic nerves of *Pecten maximus* in response to changes in light intensity, and to pattern and movement in the optical environment. *J. Exp. Biol.* **45**:83.
- LAND, M. F. 1966 *b*. A multilayer interference reflector in the eye of the scallop, *Pecten maximus*. *J. Exp. Biol.* **45**:433.
- LASANSKY, A., and M. G. F. FUORTES. 1969. The site of origin of electrical responses in visual cells of the leech, *Hirudo medicinalis*. *J. Cell. Biol.* **42**:241.
- McREYNOLDS, J. S., and A. L. F. GORMAN. 1970. Photoreceptor potentials of opposite polarity in the eye of the scallop, *Pecten irradians*. *J. Gen. Physiol.* **56**:376.
- MILLECCHIA, R., and A. MAURO. 1969. The ventral photoreceptor cells of *Limulus*. III. A voltage-clamp study. *J. Gen. Physiol.* **54**:331.
- MPITSOS, G. J. 1969. An electrophysiological analysis of the vision in a file clam (*Lima scabra* Born). Ph.D. dissertation, University of Virginia.
- NOLTE, J., and J. E. BROWN. 1969. The spectral sensitivities of single cells in the median ocellus of *Limulus*. *J. Gen. Physiol.* **54**:636.
- RUSHTON, W. A. H. 1959. A theoretical treatment of Fuortes' observations upon eccentric cell activity in *Limulus*. *J. Physiol. (London)*. **148**:29.
- SMITH, T. G., and J. E. BROWN. 1966. A photoelectric potential in invertebrate cells. *Nature (London)*. **212**:1217.
- SMITH, T. G., W. K. STELL, and J. E. BROWN. 1968. Conductance changes associated with receptor potentials in *Limulus* photoreceptors. *Science (Washington)*. **162**:454.
- TAUC, L., and H. M. GERSCHENFELD. 1961. Cholinergic transmission mechanisms for both excitation and inhibition in molluscan central synapses. *Nature (London)*. **192**:336.

- TOYODA, J. I., H. NOSAKI, and T. TOMITA. 1969. Light-induced resistance changes in single photoreceptors of *Necturus* and *Gekko*. *Vision Res.* 9:453.
- TOYODA, J. I., and R. M. SHAPLEY. 1967. The intracellularly recorded response in the scallop eye. *Biol. Bull. (Woods Hole)*. 133:490.
- WALD, G. 1965. Visual excitation and blood clotting. *Science (Washington)*. 150:1028.
- WALD, G., P. K. BROWN, and I. R. GIBBONS. 1963. The problem of visual excitation. *J. Opt. Soc. Amer.* 53:20.
- WALD, G., and E. B. SELDIN. 1968. The electroretinogram and spectral sensitivity of the common scallop. *Biol. Bull. (Woods Hole)*. 135:441.