

Studies on the Effects of Gaseous Ions on Plant Growth

*I. The influence of positive and negative air ions on the growth of *Avena sativa**

ALBERT P. KRUEGER, SADAO KOTAKA, and
PAUL C. ANDRIESE
with the technical assistance of EDDIE J. REED.

From the Department of Bacteriology and the Naval Biological Laboratory of the School of Public Health, University of California, Berkeley

ABSTRACT Exposure of *Avena sativa* seedlings to unipolar ionized atmospheres of either charge produced statistically significant stimulation of growth as measured by mean stem length, integral elongation, and dry weight. The extent of growth increase was related to the atmospheric ion density and this in turn determined the magnitude of current flow to ground. The minimal current measured in the ground circuit and capable of producing a measurable difference in growth was 4.3 to 4.6×10^{-13} amp/plant.

INTRODUCTION

There have been many studies on the effects produced in plants by electrical currents and certain of their functional responses are well established. Bose (1) showed that various types of electrical stimulus will evoke measurable mechanical effects such as contraction of pulvinar cells in *Mimosa* with resultant downward displacement of the leaf. He also observed that cathode "break" and anode "make" shocks accelerated growth while cathode make and anode break retarded it.

A related phenomenon, the irritable responses of plants to atmospheric electricity, has been more difficult to evaluate. Interest in the role of atmospheric electricity in nature and especially in its potentiality for increasing crop yields can be traced to the very early literature. In 1775, Father Giambattista Beccaria of the University of Turin (2) stated that "it appears manifest that nature makes extensive use of atmospheric electricity for promoting vegetation" and "besides the mild electricity by excess (positive electric action of low tension) which as I have observed for these many years past constantly

prevails when the weather is serene and certainly contributes to promote vegetation, we have also observed that artificial electricity without sparks has the same effect." Within the next few years this causal relationship was independently conceived and explored by Bertholon (3), Gardini (4), and Ingenhousz (5).

During the 19th century several French and English natural philosophers concluded that atmospheric electricity is important in the growth cycle of plants (6, 7). Later Lemström (8) found that an electrical discharge from metallic points placed above cereal seedlings produced a detectable stimulation of growth. These results, obtained some 14 years before the existence of gaseous ions was demonstrated, were confirmed by Gassner in 1907 (9).

Early in the present century more extensive laboratory and field tests revealed a variety of plant responses to atmospheric electricity (10–17). Although not all the results can be discussed here sufficient are presented to indicate the scope of this work.

Stoppel (14) studied the sleep movements of *Phaseolus multiflorus* and established a periodicity which she concluded was due to the diurnal variation in atmospheric conductivity. Also she showed that normal leaf movements are disturbed by completely insulating the plant from the earth and the surrounding air. When the insulating network was given an artificial positive charge, normal movements were reestablished; a negative charge was ineffective. A few observations were made with artificially ionized air, but they are difficult to interpret because of the lack of quantitative measurements. Blackman *et al.* (10) in 1923 conducted a meticulously controlled study of the growth of the coleoptile of individual barley seedlings treated with an electrical discharge from a point 20 cm above the plants in the absence of light. The rate of growth for an hour immediately prior to treatment was determined and compared to the rate during a 5 hour exposure to the discharge. The crest value of the voltage was 10,000 volts and the current passing through the coleoptile was approximately 0.5×10^{-10} amp. An increase in the rate of growth was observed whether the point was positively or negatively charged, but the effect was significantly greater in the former case. A curious after-effect occurred, consisting of a continued rise in the growth rate persisting for several hours after cessation of the discharge. Again the phenomenon was more marked when the point was positively charged. Blackman and his colleagues considered that the observed response was a result of the passage of current through the coleoptile and that air ions were involved only as a means of conducting the current.

This series of experiments was followed by tests in pot cultures (18). Observations were made for four years on the growth of wheat, barley, and maize in pots exposed to electrical discharges from overhead wire networks averaging 1×10^{-11} amp/plant at approximately 16,000 volts. Of twenty-eight separate

sets, twenty-three showed increases in dry weight. In maize the percentage increase was 27 ± 5.8 per cent and in barley 18 ± 2.4 per cent. Alternating current was slightly more effective than direct current and both positive and negative charges of the network enhanced growth.

In larger scale experiments with field crops of oats, wheat, and barley (19), thin wires were strung 7 feet above the soil with an applied voltage of 40,000 to 80,000 volts in order to maintain a current of 0.5 to 1.0 milliamperes/acre. Of eighteen satisfactory experiments, fourteen showed increases in crop yield and four were negative. Of the fourteen positive experiments, eleven exhibited increases greater than 10 per cent and nine were above 30 per cent.

Not everyone agrees that plants respond to atmospheric electricity by an increase in the rate of growth. Collins *et al.* (20) devoted 4 years to a very critical attempt to reproduce the results reported by Blackman *et al.* They established conditions for laboratory experiments sufficiently sensitive to detect increases of as little as 3 to 5 per cent in mean elongation of the aerial parts of maize or barley seedlings. No significant differences in growth were detectable between control and treated plants. L. J. Briggs and his coworkers spent 10 years on field and greenhouse experiments under carefully controlled conditions with negative results (21).

We became interested in doing further work on this subject for three reasons:

1. During the past several years we have observed interesting physiological effects in bacteria and a variety of small mammals exposed to air ions and have uncovered a biochemical mechanism that appears to account for some of the functional changes in mammalian tissues (22). We felt that similar observations on the responses of higher plants would be useful in improving our understanding of the mechanisms by which air ions may modify life processes.

2. The earlier experimenters who described irritable responses in plants exposed to atmospheric electricity did not define their experimental conditions with respect to air ions. Stoppel (14), Lipperheide (15), and Musso (12) used "ionized air" without separating or distinguishing between positive or negative ions. Quantitative determination of air ion concentration either was not done at all or was limited to estimates of increased air conductivity. Blackman and his colleagues (10) mentioned air ions only as a means of delivering small electrical currents to the plants. The chemical nature of the ions involved in transmission of the current through air was not considered important; we have found that the biological effects of atmospheric electricity frequently depend upon specific ion types (22).

3. Recent technological advances in the generation and measurement of gaseous ions make it possible to exercise more precise control of experimental conditions and to eliminate some of the uncertainty attending earlier work.

MATERIALS AND METHODS

1. *First Experiment. Oct. 31 to Nov. 12, 1960* The experiments described here were performed with oats (*Avena sativa*, var. Kanota) kindly provided by the Department of Agronomy, College of Agriculture, University of California at Davis, and by the Ferry-Morse Seed Company of Mountain View, California. Seeds of uniform size selected by hand were husked and maintained in a desiccator at 25°C.

Sand for the growth substrate was prepared as follows: No. 30 sea sand was treated with 15 N·H₂SO₄ for 72 hours and was then washed continuously with tap water until a negative sulfate reaction was obtained. After thorough washing with distilled water, the sand was dried at 350°C and was placed in the plastic trays described below.

The nutrient solution used contained the following components: MgSO₄ 3×10^{-3} M; K₂SO₄, KNO₃, and Ca(NO₃)₂ each 1×10^{-3} M; MnCl₂, ZnSO₄, and H₃BO₃, each 3×10^{-6} M and KI 3×10^{-7} M (23). One-half ml of 0.5 per cent solution of ferric citrate was added to 1,000 ml of nutrient solution prior to use. The final pH of the preparation was 6.8. Each day the old nutrient solution was replaced.

As containers for the sand cultures, we used plastic trays 14 × 12 × 2 inches. Each container had a hole 5 mm in diameter near the bottom, into which was inserted a strip of cheesecloth for drainage of the nutrient solution. After draining the opening was closed with a rubber stopper.

The planting area of the sand in the containers was divided into 1 × 1 inch numbered squares for use in random sampling. Just prior to planting, the sand was charged with nutrient solution.

Husked oat seeds were removed from the desiccator, soaked in distilled water for 3 hours, and then were planted one to a square in the moist surface layer of the sand. Three such seeded containers were prepared at a time; one was placed in a negative ion chamber, one in a control chamber, and one in a positive ion chamber; all were grounded with No. 20 tinned copper-stranded hook-up wire. The air in each chamber was monitored daily for the densities of small and large ions of either charge (24).

Fig. 1 shows the arrangement of the individual plant culture unit within the cubicle. In addition to the 15 watt daylight type fluorescent light shown 45 cm above the sand surface, each cubicle has an ordinary 60 watt light bulb in the ceiling, some 100 cm above the sand. Light was provided for 8 hours per day.

The ion generators installed on the floor of the positive and negative cubicles near the air intake provide unipolar ionized atmospheres which show a normal gradient of ion loss as the air moves from floor level intake to ceiling exhaust port. In the plant test sites of Experiment 1 the small ion density in the negative cubicle averaged 5×10^3 /cm³ and in the positive cubicle 5.9×10^3 /cm³. Additional ions were supplied as needed from tritium ion generators mounted 30 cm above the sand surface. With the culture substrate grounded and with an applied voltage of 955 volts in the rectifying circuit, single tritium generators used in the first experiment produced a steady ion output of 1×10^9 positive or negative ions/cm²/sec. as measured with the Beckett probe and micromicroammeter at a distance of 3 cm from the tritium foil. Measurements made 2 cm above the surface of the sand surface showed considerable fluctuation because of the variable air currents in the cubicle (25).

Changes in length, fresh weight, and dry weight were used to detect any effect of air ions on plant growth. At 2 day intervals ten seedlings from each test plot were selected by reference to a table of random numbers (26). The endosperm was detached from each seedling and the latter was washed in distilled water to remove sand grains and endosperm substance from the roots. Surplus water was removed with filter paper.

The length of coleoptile and stem was measured on a glass plate graduated in millimeters. Stem length was defined as the distance between the apex of the longest leaf and the base of the endosperm. Fresh weight of the whole seedlings including stems

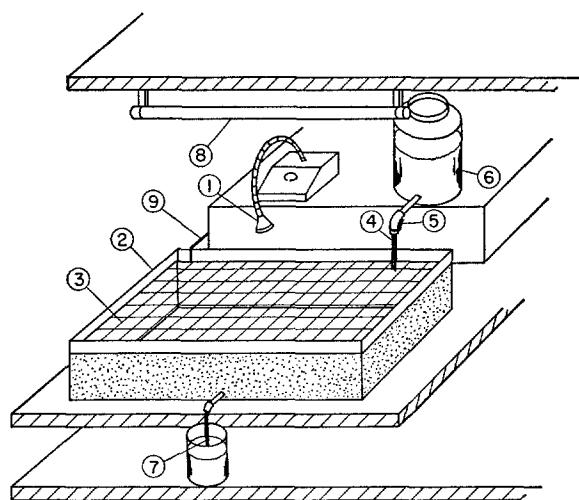

FIGURE 1. Details of planter box arrangement for experiments 1 and 2. (1) Tritium air ion generator with reversible rectifying circuit. (2) Plastic tray 14 × 12 × 2 inches. (3) 1 × 1 inch marker for placement of seeds. (4) Cheesecloth drain. (5) Stopcock. (6) Culture medium. (7) Cheesecloth drain. (8) 15 watt daylight fluorescent lamp. (9) Ground wire.

and roots was determined on a chemical balance. Subsequently the seedlings were dried in an oven at 55°C for 72 hours and in a calcium fluoride desiccator for 3 hours and the weight again determined.

2. Second Experiment. April 4 to 24, 1961 In the second experiment the dosage of ions administered to the seedlings was increased by placing four tritium generators in a horizontal square 25 cm to a side at a distance of 30 cm above the grounded planters (*high dosage* in text). The total ion current output of the four generators was determined by placing a probe 2 cm from each tritium foil and measuring the amperage with a micromicroammeter. The negative ion current was 1.0×10^{-8} amp and the positive ion current was 1.2×10^{-8} amp. Electrical field distortions of some magnitude were encountered and were partially corrected by suspending a bare grounded copper wire vertically at the center of the square with the free tip of the wire 3 cm above the sand. Since measurements of ion flow conducted with the probe close to the

sand surface fluctuated too much to be significant, the effective ion current was determined by introducing a micromicroammeter into the ground circuit adjacent to the planters and placing long leakage path insulators under each tray.

For comparison with this high ion dosage, identical grounded trays were exposed to the background ionized atmospheres in the negative and positive cubicles without the use of additional generators (*low dosage* in text). In the test sites the air ion content determined with a Wesix ion collector and micromicroammeter averaged 1.2×10^4 negative ions/cm³ and 1.3×10^4 positive ions/cm³. Only occasionally were we able to detect a few ions of opposite charge in the unipolar atmospheres.

In addition to an entirely untreated control in this experiment, we included two electrical field controls. These were employed to detect any changes in growth rates due to the electrical fields *per se* or to the small ionic currents carried by the sparsely ionized air normally present in the control chamber (average values = 250 (+) ions/cm³ and 200 (-) ions/cm³). For this purpose, two grounded trays of plants were placed in the control cubicle and 30 cm above each was suspended a wire screen of the same dimensions as the trays. Leads from the rectifying circuits of two ion generators (with ion sources removed) produced a positive potential of 955 volts on one screen (positive electrical field control) and an equivalent negative potential on the other (negative electrical field control). The light source, culture medium, and temperature were identical with those outlined for Experiment 1.

Instead of randomly harvesting groups of plants for measurement of growth as in Experiment 1, we measured the stem length of all the plants *in situ* with a ruler graduated in millimeters. This was done every other day, beginning with the 4th day after seeding and concluding on the 22nd day.

3. *Third Experiment. June 25 to July 28, 1961* Experiment 3 was conducted with seedlings already 15 to 20 mm high at the start of exposure to gaseous ions. *Avena sativa* seeds were soaked in tap water for 20 hours and were allowed to germinate on a layer of wet cheesecloth in a moist chamber. Vigorous aeration and indirect lighting were provided and the temperature was maintained at 25°C. By the 4th day growth was well advanced and seedlings with a coleoptile length of 15 to 20 mm were removed, randomized, and transplanted to the culture boxes. These were $7\frac{1}{2} \times 5\frac{1}{4}$ inches and $2\frac{3}{4}$ inch plastic boxes with eight holes drilled in the bottom. Cheesecloth wicks were inserted through two of the holes at opposite ends and a layer of cheesecloth placed in the bottom of each box. Treated sand was poured into all the boxes to a depth of 2 inches. Wire screen with a 1 × 1 inch mesh was placed on the surface of the sand and seedlings were planted in twenty-eight of the squares in each box. Because of certain deficiencies noted in the culture medium used in the first two experiments the following formula was substituted: Ca(NO₃)₂ · 4 HOH 3.1×10^{-3} M; KCl 4.4×10^{-3} M; KNO₃ 4×10^{-3} M; KH₂PO₄ 1.4×10^{-3} M; MgSO₄ · 7 HOH 1.5×10^{-3} M; MnCl₂ 1.6×10^{-4} M; H₃BO₃ 1.3×10^{-4} M; ZnSO₄ · 7 HOH 4.7×10^{-5} M; KI 2.2×10^{-5} M; (NH₄)₆Mo₇O₂₄ · 4 HOH 9.3×10^{-5} M (27). Iron was supplied by adding 1 ml of 5 per cent ferric citrate solution to 1 liter of medium just prior to use. The pH of the solution was 6.7 and the medium was changed once a week.

Seven culture boxes prepared as above were divided among the three exposure cubicles as follows: One high dosage negative ion unit, one low dosage negative ion

unit, one high dosage positive ion unit, one low dosage positive ion unit, one negative electrical field control, one positive electrical field control, one untreated control. The arrangements of the ion generators, ground wires, and the screens for the electrical field controls were the same as those used in Experiment 2. Each of the seven boxes was illuminated for 8 hours daily with one 60 watt incandescent lamp and one 15 watt daylight type fluorescent lamp, both located 49 cm above the sand surface.

Growth was followed by measuring the integral elongation of the plants. At stated intervals we measured the length of coleoptile of each seedling. From the mean of these measurements for a given box was subtracted the mean initial coleoptile length determined at the time of transplanting (1st day of exposure). As the leaves and internodes appeared, the length of each was measured, the mean values calculated, and these values were added to the mean coleoptile length. From this sum was subtracted the mean initial coleoptile length. At the termination of the exposure period (28 days) the seedlings were harvested and fresh dry weights were determined as described above.

The currents flowing through the planters were measured by the procedure outlined in Experiment 2.

EXPERIMENTAL RESULTS

Experiment 1

In this experiment one seeded tray was exposed to negative ions, one to positive ions, and one was kept in the control chamber. Stem length, fresh weight, and dry weight were determined for sets of ten seedlings selected at random from each tray at intervals of 2 days.

No drastic ion-induced effects on germination were noted. On the 4th day after seeding, germination had occurred in 85 per cent of the seeds exposed to negative ions, in 83 per cent of those exposed to positive ions, and in 70 per cent of the controls.

Growth as measured by stem length was stimulated in both ion-treated groups (Fig. 2). Although fresh weight values showed only minor differences among the three groups of plants (Fig. 3), significant increases in dry weight were found in both ion-treated sets (Fig. 4).

Experiment 2

Experiment 2 was a more extensive test of air ion effects employing multiple generators to produce high dosage conditions; low ion density levels were achieved by exposing grounded trays to the unipolar ionized atmospheres of the negative and positive cubicles without additional ion generators. Electrical field controls were placed in the control chamber with an untreated control.

Figs. 5 and 6 show the effects of air ions on mean stem length. Under the conditions described as high dosage and low dosage of either charge the plants grew faster than the untreated controls. The growth of the plants

exposed to negative ions was significantly greater than that of the plants exposed to positive ions. A slight increase in growth rate over the untreated controls was observed in both electrical field controls despite the fact that the ion densities in the control cubicle averaged only 200 (–) ions/cm³ and 250 (+) ions/cm³.

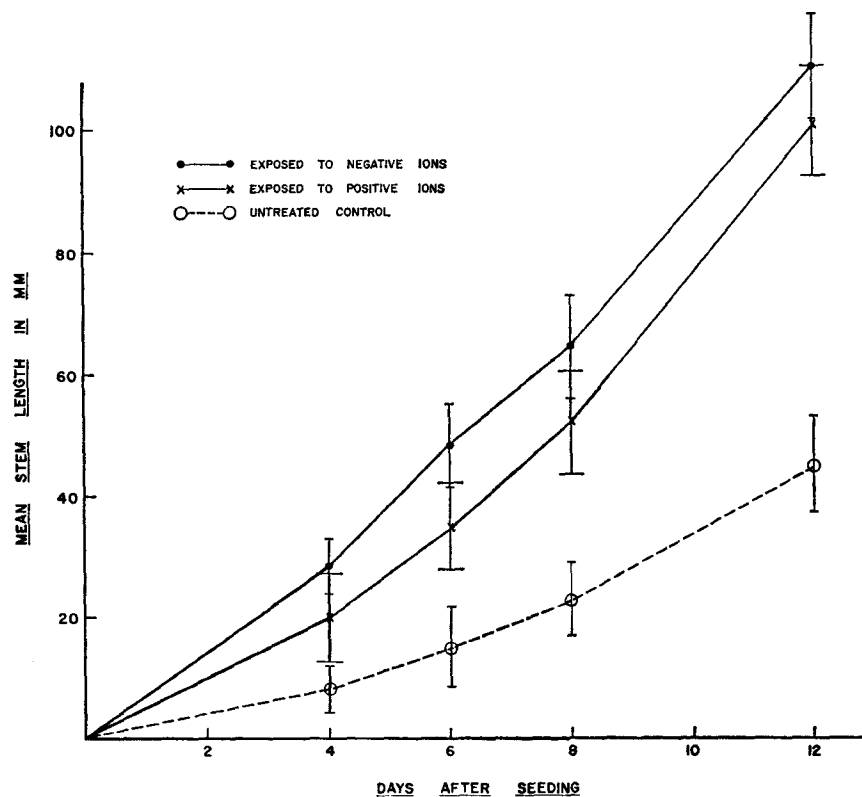

FIGURE 2. Experiment 1. Effect of unipolar ionized atmospheres on growth of *Avena sativa*. The plants were grown from seed; at 2 day intervals ten random samples were removed and the mean stem length determined. The points for the 2nd and 10th days are not shown but fall on the curves as drawn. The vertical bars represent 95 per cent confidence intervals.

Experiment 3

This experiment differed from the first two in avoiding any possible effects of air ions on germination, in utilizing integral elongation of all aerial parts of the plants as the measure of growth, and in substituting a better culture medium to correct possible N and K deficiencies.

The ion densities employed were essentially the same as in Experiment 2. Figs. 7 and 8 show the results of exposure to negative ions and positive ions respectively. Apparently when integral elongation is used as the measure of

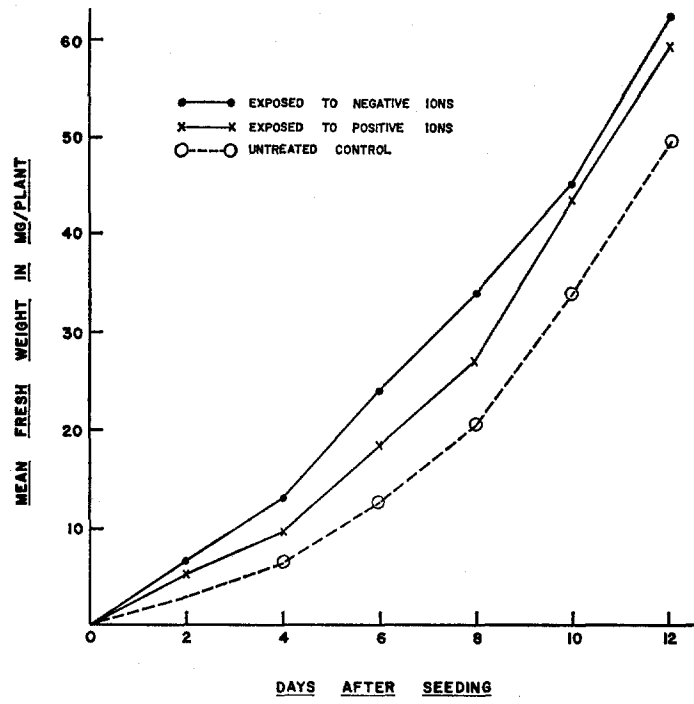

FIGURE 3. Experiment 1. Effect of unipolar ionized atmospheres on fresh weight of *Avena sativa*.

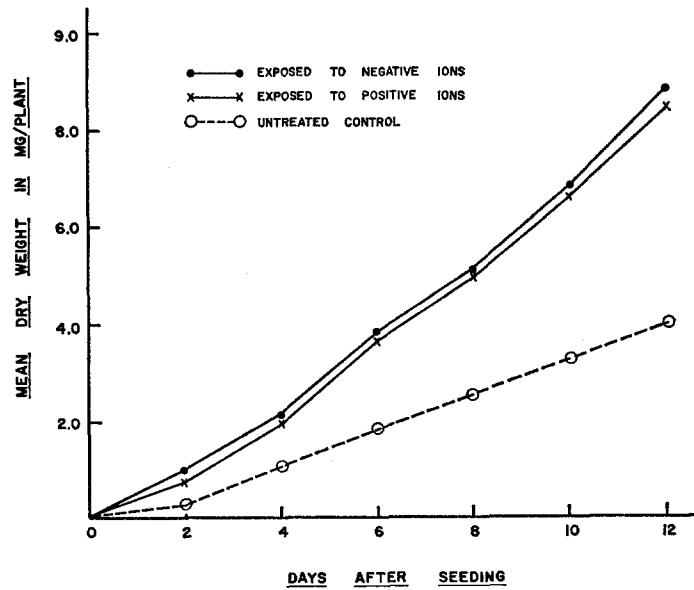

FIGURE 4. Experiment 1. Effect of unipolar ionized atmospheres on dry weight of *Avena sativa*.

growth rather than mean stem length, the differences in growth rates observed in Experiment 2 between negative high dosage and low dosage and between negative field control and untreated control disappear. This occurs also in the case of the positive field control and the untreated control. However, a significant difference is evident between positive high dosage and low dosage. The curves of integral elongation in negative high dosage, negative

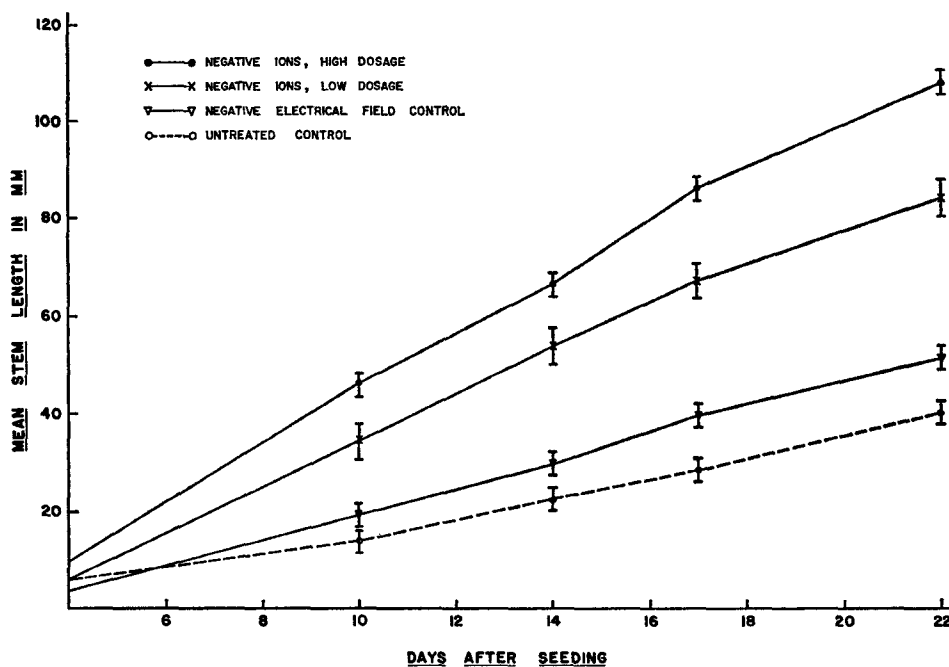

FIGURE 5. Experiment 2. Effect of high dosage and low dosage negative unipolar ionized atmospheres on growth of *Avena sativa*. The stem length measurements were made *in situ* every other day. Only four points are shown; those not shown fall on the curves as drawn. The vertical bars represent 95 per cent confidence intervals.

low dosage, and positive high dosage plants are practically identical and exhibit marked increases compared to the untreated controls.

The fresh weight values for the aerial parts plus roots showed a slight increase over the untreated control seedlings as a result of high and low dosages of positive ions (Table I). A more marked difference occurred in the plants exposed to negative ions. Both electrical field controls were practically identical with the untreated control seedlings. Essentially the same relationships were found in the dry weight values except that exposure to high and low dosages of negative ions produced a more marked increment over the controls than was observed in the fresh weight.

Measurements of the current flowing to ground in Experiments 2 and 3 were made as outlined under Methods and the values are given in Table II. High dosage negative and positive current values were almost identical when the planters were empty. When the seedlings were 15 days old the high dosage negative current was nearly double that of the empty planter; the high dosage positive current was approximately four times that of the empty planter.

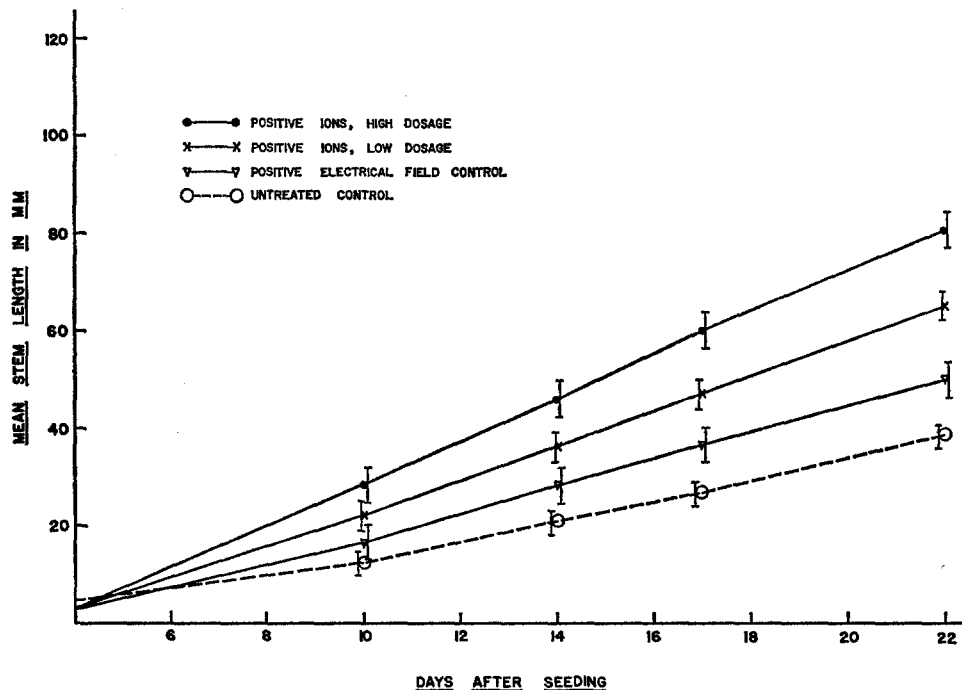

FIGURE 6. Experiment 2. Effect of high dosage and low dosage positive unipolar ionized atmospheres on growth of *Avena sativa*. The stem length measurements were made *in situ* every other day. Only four points are shown; those not shown fall on the curves as drawn. The vertical bars represent 95 per cent confidence intervals.

The low dosage values for negative and positive current showed no great difference either in the case of the empty planters or in the presence of seedlings. Comparing the low dosage current with plants and without plants the ratios are 2:1 for the negative ion treatment and 4:1 for positive ion treatment; *i.e.*, the same ratios observed for high dosage.

Considering the situation within the control cubicle where the ion content of the air averages only 200 (–) ions/cm³ and 250 (+) ions/cm³, it is evident that the current to ground is increased significantly by the applied potential differences. In the absence of an electrical field the current was too small for

accurate determination ($< 1 \times 10^{-13}$ amp) and fluctuated considerably. The empty planters of both negative and positive field controls carried a current of 2.2×10^{-12} amp; with plants present the current was increased about fivefold in each case to within some 50 per cent of the negative and positive low dosage values.

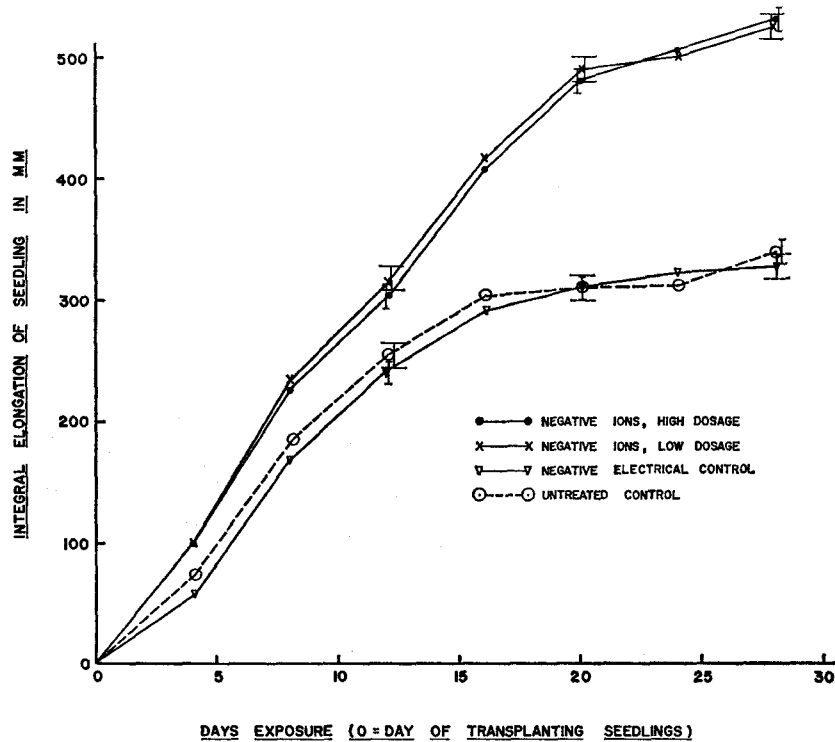

FIGURE 7. Effect of high dosage and low dosage negative unipolar ionized atmospheres on growth of *Avena sativa*. The ordinate represents integral elongation of the seedlings measured every other day *in situ*. Points not shown fall on the curves as drawn. The vertical bars represent 95 per cent confidence intervals.

DISCUSSION

It appears to us that the careful and extensive work of Blackman and his colleagues on single plants (10), on statistically significant numbers of plants in pots (18), and finally on field crops (19) has demonstrated beyond any reasonable doubt that a high voltage discharge into air above plants will accelerate growth and increase crop yield. The voltages employed ranged from 10,000 v. in the single plant experiments to 100,000 v. in some of the field crop tests (field strengths approximated 500 v/cm). Our late colleague,

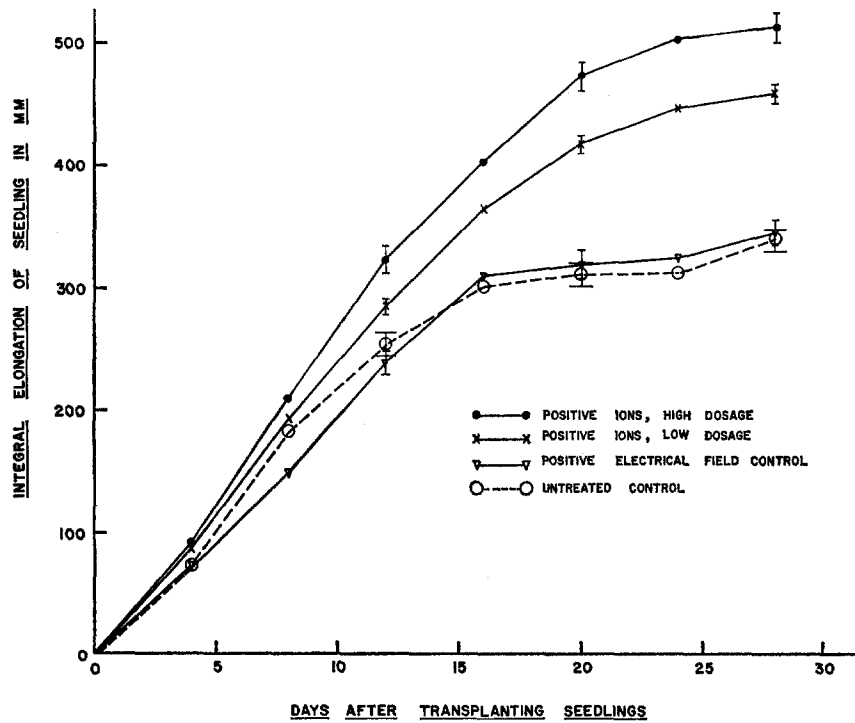

FIGURE 8. Effect of high dosage and low dosage positive unipolar ionized atmospheres on growth of *Avena sativa*. The ordinate represents integral elongation of the seedlings measured every other day *in situ*. Points not shown fall on the curves as drawn. The vertical bars represent 95 per cent confidence intervals.

W. Wesley Hicks (28), and Stetson (29) have reported similar results with a variety of plants.

The delivery of electrical current from source to plant depends, of course,

TABLE I
EFFECT OF ATMOSPHERIC ELECTRICITY ON FRESH AND DRY WEIGHT OF OAT SEEDLINGS
EXPERIMENT 3

Mean weight in mg/ plant	High dosage		Low dosage		Electrical field controls		Untreated control
	(-)	(+)	(-)	(+)	(-)	(+)	
Fresh weight	445	350	420	335	277	275	270
Dry weight	61.5	43.5	59	42.5	33.5	34.5	35.0

The aerial parts and roots were weighed at the end of the experiment (28th day). There were thirty plants in each test group.

upon the ionic content of the ambient air, for which we have reliable measurements. Earlier experimenters, however, did not collect comparable data on air ion densities nor did they commonly employ unipolar ionized atmospheres. Accordingly, we have related our experimental results to theirs through a common denominator: measurements of the currents picked up by plants and conducted to ground. In Blackman's experiments the current to ground per plant was as low as 1×10^{-11} amp for laboratory tests on simple plants, and as high as 1×10^{-10} amp in the case of field crops. In our high dosage sets the current flow to ground was close to the lower limit of this range, (-) 6.4×10^{-12} amp, and (+) 1.6×10^{-11} amp. In the low dosage sets the nega-

TABLE II
THE ELECTRICAL CURRENTS PREVAILING
IN EXPERIMENTS 2 AND 3

		Without plants	With plants
Negative cubicle	High dosage	1×10^{-10} amp	1.8×10^{-10} amp
	Low dosage	1×10^{-11} amp	2.5×10^{-11} amp
	Negative field control	2.2×10^{-12} amp	1.2×10^{-11} amp
Control cubicle	Positive field control	2.2×10^{-12} amp	1.3×10^{-11} amp
	No electrical field	$<1 \times 10^{-13}$ amp	$<1 \times 10^{-13}$ amp
	High dosage	1.2×10^{-10} amp	4.5×10^{-10} amp
Positive cubicle	Low dosage	6×10^{-12} amp	2.8×10^{-11} amp

The currents flowing to ground were measured with a micromicroammeter.

tive current was approximately 15 per cent of the high dosage value and the positive current was 6 per cent of the high dosage value.

The smallest currents we found to be associated with measurable changes in growth rate were observed in the electrical field controls of Experiment 2: (-) 4.3×10^{-13} amp and (+) 4.6×10^{-13} amp per plant or approximately 4.5 per cent of the smallest currents recorded by Blackman *et al.* Here stem length alone was measured; when the criterion of growth was integral elongation (Experiment 3), the curves of both electrical field controls were indistinguishable from the untreated control curve. Exposure to atmospheric electricity was continuous in our experiments and intermittent in those of Blackman *et al.*

Judging from the data of Experiment 2 plants are capable of responding by alterations in rate of growth to conditions which result in very small differences in the current carried. In Fig. 5 for example, a statistically significant difference in growth rate occurred when the current per plant changed from (-) 6.4×10^{-12} amp to (-) 9×10^{-13} amp (high dosage and low dosage values). This also took place when the current per plant fell from (-) 9×10^{-13} amp to (-) 4.3×10^{-13} amp (low dosage and electrical field

control values). Corresponding but less marked changes are apparent in Fig. 6 for positive currents. Here the currents per plant were: high dosage (+) 4.5×10^{-10} amp, low dosage (+) 1×10^{-12} amp, and electrical field control (+) 4.6×10^{-18} amp.

There is some indication that the naturally prevailing air-earth current has a favorable though slight effect on growth. If plants such as barley or maize are protected from this current by a grounded screen the dry weight of the plants is less than normal (18).

One of the most intriguing features of the growth response has been the after-effect of exposure to atmospheric electricity. Blackman *et al.* observed this phenomenon in their work with individual barley seedlings (10). In pot culture experiments with barley (18) treatment for the 1st month after planting was equivalent in effect to treatment throughout the season.

We have not included discontinuous exposure experiments in the present series but it is pertinent that a comparable after-effect occurs in animals. When mice are kept in unipolar ionized atmospheres for several days the rate of ciliary beat of the tracheal epithelium rises if the charge is negative and falls below normal levels if the charge is positive. If the animals are then removed to an untreated atmosphere the altered rates are maintained for relatively long periods of time (30). This after-effect extends to ion-induced alterations in the state of the vascular bed and the vulnerability to trauma.

Another aspect of the plant response to atmospheric electricity is the tendency of the leaves to attain a deeper green color than they normally display (15, 16). We have observed this phenomenon in our experiments but have not investigated the mechanism involved.

The early work quoted above and our own experiments do not explain how atmospheric electricity exerts its action on growth, sleep movements, etc. Blackman *et al.* (19) concluded that the very small current involved stimulates plant growth through some unknown channel and that the only function of air ions is the delivery of this current. We doubt that the action of air ions is limited to transmission of the electrical current, for in a considerable amount of work undertaken to detect effects of atmospheric electricity on bacteria and small mammals the chemical nature of the ion also was a determinant (22). For example, it was found that CO_2^+ alone could produce inhibition of ciliary action, increased vulnerability to trauma, and vasoconstriction in the tracheal mucosa; only O_2^- could specifically reverse these effects. The currents involved were of the same order of magnitude and other gases with the same ion current produced no effects.

It is possible that deficiencies in the number and/or type of gaseous ions present in the atmosphere may account for the completely negative results obtained by Collins *et al.* (20) and by Briggs (21) in attempting to stimulate plant growth by means of electrical currents discharged into the air.

We are presently conducting experiments designed to determine whether specific types of gaseous ions actually are essential to increase plant growth and what mechanisms within the plant are responsible for this increase.

This research was supported by (1) a contract with the United States Air Force (A.F. 49(638)-669) monitored by the Air Force Office of Scientific Research of the Air Research and Development Command, (2) a grant from the National Institutes of Health, and (3) a grant from the Committee on Research of the University of California.

We wish to express our thanks to John C. Beckett for his help in dealing with electrical problems encountered in this work.

The opinions expressed herein are not necessarily those of the Navy Department or of the Air Force.

Received for publication, October 11, 1961.

BIBLIOGRAPHY

1. BOSE, J. C., *Plant Response as a Means of Physiological Investigation*, London, Longmans and Co., 1906. *Researches on Irritability of Plants*, London, Longmans, Green and Co., 1913.
2. BECCARIA, G., *Della Elettricità Terrestre Atmosferica a Cielo Sereno*, Torino, 1775.
3. BERTHOLON, M., *De l'électricité des vegetaux*, Paris, 1783.
4. GARDINI, C., *De influxu electricitatis atmosphericae in Vegetantia*, Turin, 1784. Dissertation.
5. INGENHOUSZ, J., *Lettre à M. Molitor an sujet de l'influence de l'électricité atmospherique sur les vegetaux*, *J. physique*, l'abbe Rozier, 1788.
6. GRANDEAU, L., *Compt. rend. Soc. biol.*, 1878, **37**, S.60, 285, 939.
7. STURGEON, W., *On the electro-culture of farm crops*, *J. Highland and Agric. Soc.*, 1846, 262-299.
8. LEMSTRÖM, S., *Electricity in Agriculture and Horticulture*, London, 1904.
9. GASSNER, G., *Ber. bot. Ges.*, 1907, **25**, 26.
10. BLACKMAN, V. H., LEGG, A. T., and GREGORY, F. G., *Proc. Roy. Soc. London, Series B*, 1923, **95**, 214.
11. HENRIGI, M., *Arch. sc. phys. et nat.*, 1921, 276.
12. MUSSO, J. O., *Bioklimat. Beiblatter, Meteorol. Z.*, 1934, **1**, 21.
13. TCHIJEVSKY, A. L., *Tr. Central Lab. Scient. Research on Ionization*, **1**, 1.
14. STOPPEL, R., *Z. Bot.*, 1916, **9**, 609.
15. LIPPERHEIDE, C., *Angew. Bot.*, 1927, **9**, 561.
16. PRIESTLEY, J. H., *J. Board Agric.*, 1910, **17**, 16.
17. GIGLIOLI, I., *Cultura del Frumento*, *R. Staz. Agr. Speriment. Roma*, Portici, 1901.
18. BLACKMAN, V. H., AND LEGG, A. T., *J. Agric. Sc.*, 1924, **14**, 268.
19. BLACKMAN, V. H., *J. Agric. Sc.*, 1924, **14**, 240.
20. COLLINS, G., FLINT, L. H., and McLANE, J. W., *J. Agric. Research*, 1929, **38**, 585.
21. BRIGGS, L. J., in *Physiology of Plants*, (W. Seifriz editor, London, J. Wiley and Sons, 1938).
22. KRUEGER, A. P., *J. Albert Einstein Med. Center*, 1960, **8**, 79.
23. ARNON, D. I., *Soil Sc.*, 1937, **44**, 91.
24. BECKETT, J. C., *Air Ion Measurement*, Presented at the International Conference

on Air Ionization, Philadelphia, Oct. 16-17, 1961; to be published in the Proceedings of the Conference.

25. SIKSNA, R., and EICHMEIER, J., *Ark. Geofysik*, 1960, **3**, 299.
26. FISHER, R. A., and YATES, F., *Statistical Tables for Biological, Agricultural and Medical Research*, New York, Hafner Publishing Co., Inc., 5th edition, 1957.
27. TURNER, W. I., and HENRY, V. A., *Growing Plants in Nutrient Solutions*, London, J. Wiley and Sons, 1939.
28. HICKS, W. W., *J. Franklin Inst.*, 1957, **264**, 1.
29. STETSON, H. T., *J. Franklin Inst.*, 1957, **264**, 169.
30. KRUEGER, A. P., and SMITH, R. F., *J. Gen. Physiol.*, 1959, **42**, 959.