

Possible Involvement of Messenger RNA-associated Proteins in Protein Synthesis

HANS-PETER SCHMID, KURT KÖHLER, and BUDDY SETYONO

Biologisches Institut, Universität Stuttgart, D-7000 Stuttgart 60, Federal Republic of Germany

ABSTRACT Two distinct forms of globin messenger RNA were isolated from mouse spleen cells infected with Friend erythroleukemia virus: polyribosomal messenger ribonucleoprotein particles (15S mRNP), and their corresponding protein-free mRNAs obtained by chemical deproteinization. The translation efficiencies of both messenger forms were assayed in a Krebs II ascites cell-free system. Selective removal of RNA-binding proteins from the ascites cell lysate did not affect globin synthesis when the mRNA was supplied as 15S mRNP; deproteinized mRNA however was not translated. Only in the presence of two fractions of RNA-binding proteins was the protein-free mRNA translated. Some of the RNA-binding proteins have the same molecular weights and isoelectric points as the principal proteins of 15S mRNP.

Many investigations support the concept that eukaryotic messenger RNA is associated with various proteins as messenger ribonucleoprotein particles (mRNP) (1–8). Two classes of mRNP can be isolated from the cytoplasm, one that consists of free mRNP not bound to ribosomes, and the other that is present in polyribosomes (1, 3, 6, 9, 10). The physiological importance of stable protein-mRNA interactions and even the existence of mRNP have sometimes been questioned, because mRNP and deproteinized mRNA stimulate the cell-free translation system equally well (11–15). Furthermore, earlier studies by Baltimore and co-workers (16, 17) indicated that the cytosol contains soluble proteins with affinity for RNA, raising the possibility that mRNPs are artifacts of cell fractionation (see discussion in Kumar and Pederson [18]). On the other hand, mRNPs can be shown to remain intact under conditions of ionic strength where nonspecific RNA-protein complexes dissociate (14, 19–23). Moreover, RNA-protein cross-linking experiments indicate that mRNA is complexed with proteins *in situ* (24–26).

These conflicting observations can be reconciled by the hypothesis that RNA-protein associations do occur *in vivo*, but that the mRNP-proteins are also present as soluble RNA-binding proteins. This view is compatible with the metabolic behavior of mRNP, which indicates that the proteins shuttle on and off the mRNA (27–29). In addition, recent data from this laboratory (30–32), as well as from others (33, 34), have shown that in fact some of the RNA-binding proteins have the same electrophoretic mobilities as the proteins isolated in association with mRNAs as native mRNP in the same cells.

Clearly, the possible role of mRNP proteins in translation cannot be investigated if one uses a translation system in which

an extensive supply of these proteins is present in soluble form. Therefore, we have devised a method for eliminating these proteins from an ascites cell lysate, by passing the lysate through a RNA affinity column (31, 32). This treatment makes translation in the lysate dependent on protein factors that bind to the column, or on some other source of factors. Using this treated lysate, we have examined the translation efficiency of mouse globin 15S mRNP (globin messenger ribonucleoprotein from polyribosomes, having a modal sedimentation coefficient of 15S) and its respective protein-free mRNA. We find that the proteins of highly purified 15S mRNP can substitute in translation for cytoplasmic proteins that bind to the RNA column. This strongly suggests that the mRNP proteins, in the form of their soluble counterparts, have an essential role in translation.

MATERIALS AND METHODS

Preparation of the Cell-free Systems

Krebs II ascites cells were allowed to multiply for 7–9 d after intraperitoneal injections of 0.2 ml of ascites fluid into BALB/c mice. Using aseptic methods the cells were removed with a syringe from freshly killed mice, transferred into precooled centrifuge tubes, and sedimented by low-speed centrifugation. All the following procedures were carried out at 0°–4°C. Ascites cells were washed twice with 145 mM NaCl; 20 mM Tris-HCl pH 7.5, and thereafter resuspended into 1 vol of hypotonic buffer (10 mM KCl, 20 mM Tris-HCl pH 7.5, 3 mM Mg-acetate, 7 mM 2-mercaptoethanol, containing 20 μM hemin). The cells were allowed to swell for 10 min, and then disrupted in a Dounce homogenizer by 20 strokes of a tight-fitting pestle, until ~90% of the cells were broken. 2 M KCl was added to give a final concentration of 100 mM. Nuclei, unbroken cells, membranes, and mitochondria were removed by centrifugation [Sorvall SS34 rotor (DuPont Co., Wilmington, DE); 30,000 g 20 min], and the postmitochondrial supernatant (PMS) was removed carefully, avoiding disturbance of the pellet and the thin

lipid film at the surface. It was passed through a 1.5×30 cm Sephadex G-25 column equilibrated with buffer (100 mM KCl, 20 mM Tris-HCl pH 7.5, 3 mM Mg-acetate, 7 mM 2-mercaptoethanol) to remove low molecular weight compounds. The filtered PMS was either used directly in the in vitro assay, or was passed through a RNA-Sepharose column in order to separate it from RNA-binding proteins, resulting in a PMS(-). Endogenous messenger was then eliminated by 30 min of preincubation with ATP, GTP, creatinine phosphate, creatine phosphokinase, and all 20 essential amino acids. Aliquots of the various PMS fractions were stored at -80°C .

The cell-free protein assay mixture (100 μl) contained the following components: 0.5 A_{260} units of preincubated PMS or PMS(-), 1 mM ATP, 40 μM GTP, 6 mM creatine phosphate, 2 IU of creatine phosphokinase, 4 μg spermidine, 30 μM of each of the 19 L-amino acids, 20 mM Tris-HCl pH 7.5, 70 mM KCl, 4 mM Mg-acetate, 1 mM Dithiothreitol, and [^3H]leucine with specific activities as indicated in the figure legends. Finally, 1 μg of mRNA, or 15S mRNP containing 1 μg of mRNA, and optimal quantities of RNA-binding protein fractions were added (see legends to the figures). The reaction mixtures were incubated at 30°C . Aliquots of 50 μl were spotted onto Whatman 3MM paper squares and treated as described previously (32).

Preparation of Globin Message from Friend Erythroleukemia Virus Infected Spleen Cells

Two inbred mice strains (BALB/c from Dr. Schäfer, Max-Planck-Institut, Tübingen, and an Agouti strain from Dr. Peters, University of Cologne) were sensitive to the Friend erythroleukemia virus complex (origin: Dr. Odaka, University of Nagoya, Japan). 20 mice were inoculated with 0.5 ml of spleen extract from previously infected mice. After 3 wk the animals were killed to remove the hypertrophic spleens. The organs were rinsed twice in ice-cold isotonic saline, then homogenized. A PMS fraction was then prepared as described above for the ascites lysate. This PMS fraction was layered over 2 ml of 30% sucrose in 100 mM KCl, 20 mM Tris-HCl pH 7.5, 3 mM Mg-acetate, 7 mM 2-mercaptoethanol, and was centrifuged for 3 h (at 34,000 rpm in the Beckman SW 40 rotor [Beckman Instrument Co., Palo Alto, CA]). The polyribosomal pellets were resuspended and dissociated in 20 mM EDTA, 100 mM KCl, 20 mM Tris-HCl pH 7.5, 7 mM 2-mercaptoethanol in an ice bath for 10 min. The suspension was diluted with 100 mM KCl, 20 mM Tris-HCl pH 7.5, 7 mM 2-mercaptoethanol, to a final concentration of 5 mM EDTA; then, it was layered over 1.5 ml of 30% sucrose in the same buffer and centrifuged at 40,000 rpm in the Beckman SW 56 rotor for 3 h in order to sediment and to remove the ribosomal subunits. The supernatant was finally analyzed by sedimentation through a 10–25% sucrose gradient in 500 mM KCl, 20 mM Tris-HCl pH 7.5, 3 mM Mg-acetate, 7 mM 2-mercaptoethanol (SW40 rotor, 36,000 rpm, 18 h). We then fractionated the gradient in 0.5-ml samples while continuously monitoring the absorbance at 254 nm; 100 μl aliquots were removed from each sample and hybridized with ^3H -poly(U), as described (35). Fractions containing 15S mRNP were collected and sedimented by centrifugation (Beckman 60Ti rotor; 48,000 rpm, 18 h). The pellet was resuspended in 70 mM KCl, 20 mM Tris-HCl pH 7.5, 4 mM Mg-acetate, 7 mM 2-mercaptoethanol, and used for in vitro translation assays. Alternatively, mRNA was extracted from this fraction using a mixture of chloroform, phenol, and isoamyl alcohol 50:49.5:0.5 (vol/vol) (36).

Isolation of RNA-binding Proteins

This method has been described in detail (30, 32). Briefly, 3 g of cyanogen bromide (CNBr)-activated Sepharose was pretreated with 1 mM HCl. The swollen gel was thoroughly washed with 0.2 M *N*-morpholino-ethanesulfonic acid (MES) pH 6.0. 30 mg of polyribosomal RNA was dissolved in the same buffer and allowed to react with the CNBr-activated Sepharose gel while being stirred gently at room temperature for 2 h. The binding of RNA was monitored by measuring the A_{260} of 20- μl aliquots. The gel mixture was then packed into a column (1 cm \times 10 cm), and rinsed extensively with 0.2 M MES pH 6.0. A high-salt buffer (500 mM KCl, 20 mM Tris-HCl pH 7.5, 3 mM Mg-acetate, 7 mM 2-mercaptoethanol) was used to remove noncovalently bound RNA, followed by a wash with 100 mM ethanolamine pH 8.0. Finally, the column was equilibrated (10 mM KCl, 20 mM Tris-HCl pH 7.5, 3 mM Mg-acetate, 7 mM mercaptoethanol) and postribosomal supernatants containing RNA-binding proteins were loaded and passed through. Proteins with affinity for RNA were eluted stepwise, first using a buffer with 350 mM KCl, 20 mM Tris-HCl pH 7.5, 3 mM Mg-acetate, 7 mM 2-mercaptoethanol, and then with 1,000 mM KCl, 20 mM Tris-HCl pH 7.5, 3 mM Mg-acetate, 7 mM 2-mercaptoethanol. The protein eluates were hence named BP350 and BP1000, and were dialyzed against 70 mM KCl, 20 mM Tris-HCl pH 7.5, 4 mM Mg-acetate, 7 mM 2-mercaptoethanol.

In Vitro Product Analysis

1 ml of assay mixture containing 5 A_{260} of preincubated PMS(-), 10 μg of mRNA, and 10 μg of BP350 and BP1000 was incubated for 1 h at 30°C . Other 1-ml reactions contained ps-mRNP, 10 μg of RNA, 10 μg of BP350 and 10 times the concentrations of components described above for cell-free protein synthesis. To remove the polyribosomes, the mixture was centrifuged at 40,000 rpm in Beckman SW56 rotor for 2 h. The supernatant was collected, and the protein product were analyzed by PAGE (37) and fluorography (38).

PAGE

The protein constituents were released from ps-mRNPs by incubation at 37°C with 10 $\mu\text{g}/\text{ml}$ of pancreatic RNase in 10 mM Tris-HCl, 100 mM KCl, 3 mM MgCl_2 , 7 mM 2-mercaptoethanol for 20 min. The mixture was then dialyzed against 21 mM 2-mercaptoethanol in H_2O and lyophilized. The RNA-binding protein fractions were subjected to the same procedure. Finally, the proteins were analyzed by two-dimensional PAGE according to O'Farrell (39).

RESULTS

Isolation of Globin mRNA and mRNP from Polyribosomes

Large amounts of globin mRNA and proteins are synthesized in the spleens of mice infected with Friend erythroleukemia virus complex (FLV cells). The grossly enlarged spleens, filled with erythropoietic cells, are an excellent source for obtaining globin mRNP and its deproteinized mRNA. Polyribosomes of these cells were dissociated with buffered EDTA. From this suspension a well-defined fraction of 15S particles could be separated that contains mRNA with poly(A) sequences, as demonstrated by hybridization with radioactive poly(U) (Fig. 1a). The mRNA has a sedimentation rate of 9S and the same electrophoretic mobility as rabbit globin mRNA (Fig. 2). Seven to ten proteins are associated with the mRNA in the 15S particle fraction. Fig. 1b shows three major bands at 48, 50, and 76 kdaltons, and minor bands at 56, 60, and 71 kdaltons.

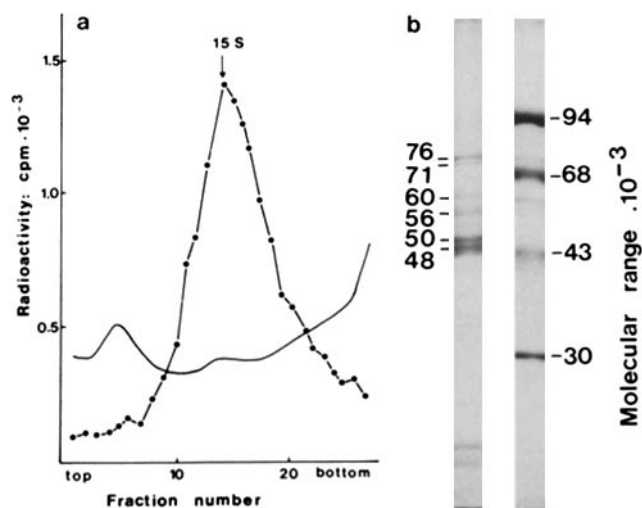

FIGURE 1 Characterization of globin mRNP from EDTA-dissociated polyribosomes. (a) Material smaller than 30S was recentrifuged through a 10–25% sucrose gradient; fractions were hybridized with ^3H -poly(U) for detecting poly(A)-containing sequences according to reference 35. (b) Protein composition of the 15S globin mRNP was analyzed by gel electrophoresis according to reference 37. Protein bands were stained with Coomassie Blue. Left lane: proteins of the pooled fractions 12–18. Right lane: M_r marker proteins: phosphorylase b (94 kdaltons), bovine serum albumin (68 kdaltons), ovalbumin (43 kdaltons) and carboanhydrase (30 kdaltons).

As we shall show subsequently, these 15S particles as well as the 9S RNA serve as messenger and stimulate the synthesis of globin *in vitro*. They are therefore referred to as 15S mRNP and globin mRNA, respectively.

Properties of a Cell-free Translation System from Krebs II Ascites Cells Devoid of RNA-binding Proteins

Evidence from earlier experiments indicated that soluble components in the postmitochondrial or postribosomal supernatants interact with the mRNA during cell-free translation (31, 32). Therefore, we have investigated these factors in more detail, using the experimental system shown in Fig. 3. The ascites PMS was cycled three times through a RNA-Sepharose column in order to remove all RNA-binding proteins. The resulting PMS(-) contains ribosomes with endogenous messengers and other translational factors. Very little translation was observed in this system (Fig. 4a, curve 1), whereas in the untreated PMS endogenous mRNA was translated for at least 30 min, as judged by the high rate of [³H]leucine incorporation (Fig. 4b). Efficient translation was restored when RNA-binding proteins were added to the PMS(-) system: addition of a fraction eluted with buffered 350 mM KCl (BP350, Fig. 4a, curve 2), or another fraction eluted with 1 M KCl (BP1000,

curve 3), slightly stimulated translation, but optimal quantities of both fractions (curve 4) restored the translation efficiency to the control (untreated) PMS level (Fig. 4b). The A_{280}/A_{260} ratio of the RNA-binding protein fractions was regularly determined and found to be 1.64. This indicates that the stimulation by BP350 and BP1000 is not due to traces of contaminating mRNAs. Also, preincubation in order to exhaust endogenous messenger activity renders the system insensitive to any stimulation by BP350 and BP1000 (results not shown). For all experiments reported here RNA-binding proteins were prepared from infected murine spleen cells, although we found that ascites RNA-binding proteins substitute for them as well; no sign of messenger activity was detected in either fraction.

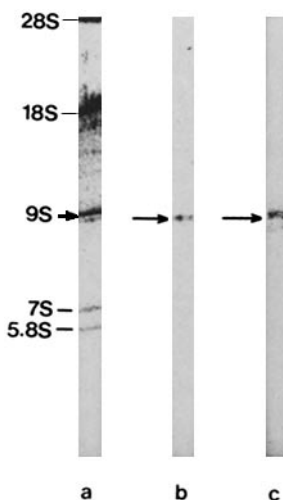

FIGURE 2 Electrophoretic analysis of globin mRNA. Deproteinized RNA was analyzed in 4-15% polyacrylamide gel gradients with 90% formamide, pH 9 according to reference 51. Electrophoresis was run at 120 V for 6 h. The gels were stained with ethidium bromide (24 μ g/ml). Lane a, 20 μ g of RNA extracted from polysomes of FLV-infected mouse spleen cells; lane b, 2 μ g of commercial 9S rabbit globin mRNA (Sigma Chemical Co., St. Louis, MO); lane (c), 2 μ g of RNA extracted from fractions 12-18 in Fig. 1 a.

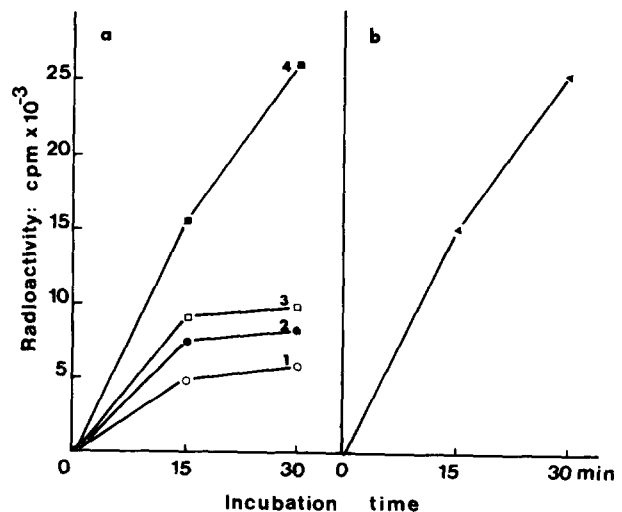

FIGURE 4 Test for the effect of RNA-binding proteins on translation of endogenous mRNA from Krebs II ascites cells. A PMS(-) system was prepared as described in Materials and Methods. (a) [³H]-Leucine incorporation programmed by endogenous mRNA in a nonpreincubated PMS(-). Curve 1, no RNA-binding proteins added; curve 2, 5 μ g of BP350; curve 3, 5 μ g of BP1000; curve 4, 5 μ g of BP350 and 5 μ g of BP1000. 200 cpm correspond to 1 pmol of leucine. (b) Control, [³H]leucine incorporation programmed by endogenous mRNA in a nonpreincubated PMS, from which RNA-binding proteins had not been removed previously, i.e., maximal endogenous activity.

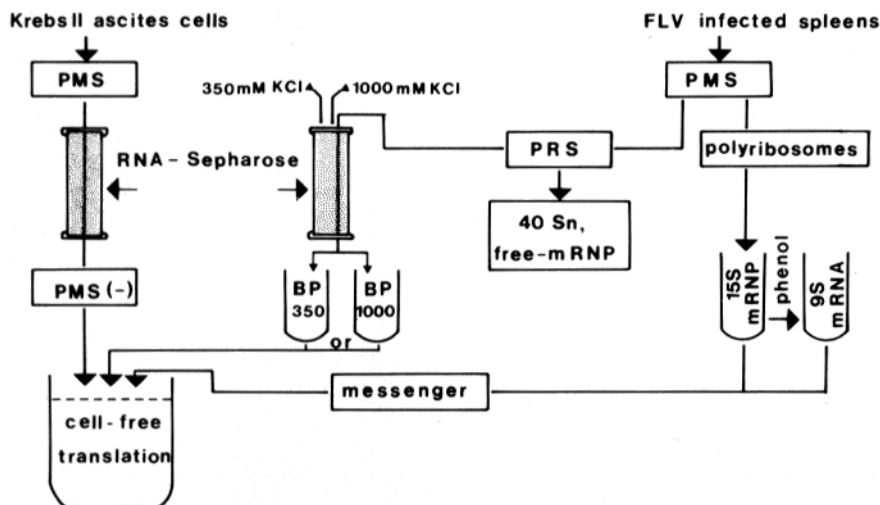

FIGURE 3 Experimental design for analyzing effects of RNA-binding proteins on cell-free translation; PRS, postribosomal supernatant; 40 S_n, free, native small ribosomal subunits; see text for details.

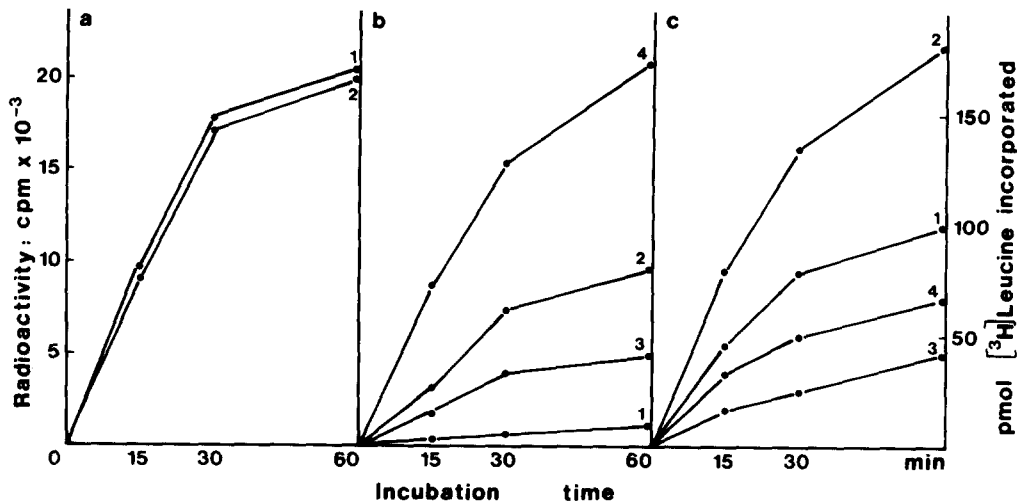

FIGURE 5 Stimulation of ^3H incorporation in preincubated PMS or PMS(-) by 15S globin mRNA or deproteinized globin mRNA. (a) Globin synthesis programmed by 9S mRNA (curve 1) and 15S mRNP (curve 2) in preincubated PMS, which contains no endogenous mRNA, but genuine RNA-binding proteins. (b) Influence of RNA-binding proteins on cell-free translation of 9S globin mRNA in a preincubated PMS(-), which contains no endogenous mRNA and no genuine

Translation of 15S mRNP and Globin mRNA in the Complete Ascites PMS and in the PMS(-) System Devoid of RNA-binding Proteins

After a 30-min preincubation of the ascites PMS or PMS(-) systems, exogenous globin messenger was added as 15S mRNP or as protein-free mRNA, and the expected translation product was determined. Specifically, the PMS(-) system enabled us to analyze the relationship between various messenger structures and RNA-binding proteins during translation, following the scheme in Fig. 3. A representative experiment is shown in Fig. 5. When equal amounts (on an RNA basis) of 15S mRNP or deproteinized globin mRNA were added to preincubated PMS, they were equally efficient (Fig. 5a). In contrast, when a preincubated PMS(-) was employed for similar experiments, the results were different: the translation efficiency of globin mRNA was greatly reduced (Fig. 5b, curve 1) and could not be increased by addition of any quantity of exogenous protein-free mRNA alone. In this PMS(-) system, globin 15S mRNP, however, did program globin synthesis (Fig. 5c, curve 1, and Fig. 6a). The stimulation was proportional to the quantity of mRNP equivalent added (results not shown). The radioactive translation product was analyzed by gel electrophoresis. Autoradiographs indicated that the radioactivity incorporated into proteins comigrated with mouse globins (Fig. 6a vs. c). From these results we conclude that 15S mRNP stimulates the synthesis of globins, whereas deproteinized globin mRNAs do not, because autoradiographs of such samples were blank (not shown). This and a series of similar experiments suggest that the deficiency of RNA-binding proteins in the PMS(-) can be compensated for by the protein moiety carried by the 15S mRNP.

Importance of RNA-binding Proteins for the Translation of Globin Polyribosomal mRNA and mRNA

In the light of the foregoing results we next considered whether translation of exogenous globin mRNA or of mRNP can be stimulated by addition of RNA-binding proteins. Fig. 5b and c shows experiments done with a PMS(-) and the globin templates. Addition of BP350 and BP1000 fractions led to pronounced globin synthesis when protein-free mRNA was chosen as template (Figs. 5b and 6b). It is obvious that neither

RNA-binding proteins. Curve 1, addition of 1 μg of 9S mRNA only; curve 2, 1 μg of 9S mRNA and 1 μg of BP350; curve 3, 1 μg of 9S mRNA and 1 μg of BP1000; curve 4, 1 μg of 9S mRNA, 1 μg of BP350, and 1 μg of BP1000. (c) Influence of RNA-binding proteins on cell-free translation of 15S globin mRNA in a preincubated PMS(-). Curve 1, addition of 15S mRNP containing 1 μg of mRNA; curve 2, 15S mRNP containing 1 μg of mRNA and 1 μg of BP350; curve 3, 15S mRNP containing 1 μg of mRNA and 1 μg of BP1000; curve 4, 15S mRNP containing 1 μg of mRNA and 1 μg of BP350, and 1 μg of BP1000.

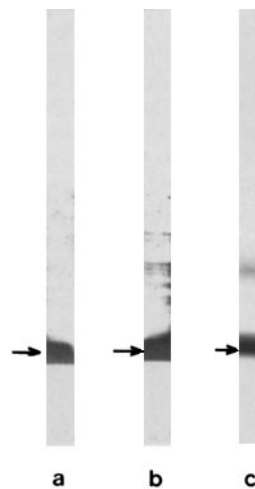

FIGURE 6 Electrophoretic analysis of the cell-free translation product programmed with globin mRNA or mRNP. Lane a, gel electrophoresis of proteins synthesized in preincubated PMS(-) with 15S globin mRNA, neither BP350 nor BP1000 fractions were added. The proteins were labeled with ^3H leucine, and precipitated with TCA. An aliquot of 50,000 cpm was loaded into the gel slot. Radioactive bands were detected by fluorography. Lane b, gel electrophoresis of proteins synthesized in preincubated PMS(-) in the presence of 9S globin mRNA, BP350, and BP1000 (other conditions as indicated for lane a). Lane c, control: electrophoresis of 5 μg of globin prepared from mouse erythrocytes. The gel was stained with Coomassie Blue (37).

BP350 or BP1000 alone yielded optimal stimulation (Fig. 5b, curves 2 and 3 vs. 4). As indicated above 15S mRNP behaved differently. It alone stimulated globin synthesis in the PMS(-) system readily in the absence of BP350 and/or BP1000 (Fig. 5c, curve 1, and Fig. 6a). The efficiency of the mRNP could be increased 50% upon addition of BP350, but BP1000, or a mixture of both, was actually inhibitory (Fig. 5c, curves 3 and 4). These data suggest that most of the observed translational efficiency of 15S mRNP, relative to the low efficiency of globin mRNA, is accounted for by the activity of proteins already bound to mRNA in 15S mRNP. This can be somewhat further increased by adding more of the BP350 fraction of RNA-binding proteins.

The Protein Composition of 15S mRNP and of the BP350 and BP1000 Fractions

To compare the proteins of the BP350, BP1000 fractions, and the 15S mRNP, we fractionated them by two-dimensional gel electrophoresis (39). As seen in Fig. 7a, electrophoresis of 15S mRNP proteins revealed a pattern of two main proteins with nominal molecular masses of 76 kdaltons, and 50 kdaltons, and two of 48 kdaltons, with isoelectric points of 5.8, 5.7, 6.8, and 6.6, respectively. Analysis of the BP350 fraction gave a pattern of >30 different proteins, but three proteins were readily identified as having the same physical properties as three components of the 15S mRNP: i.e., the 76-kdalton, and the two 48-kdalton proteins (Fig. 7b). The BP1000 fraction was composed of <20 components, among which is a 50-kdalton protein with properties identical to the 50-kdalton protein of 15S mRNP, which was missing in BP350 (Fig. 7c). The BP1000 pattern also shows the 76-kdalton protein.

DISCUSSION

In this report we demonstrate that after selective removal of RNA-binding proteins from the cell-free translation system,

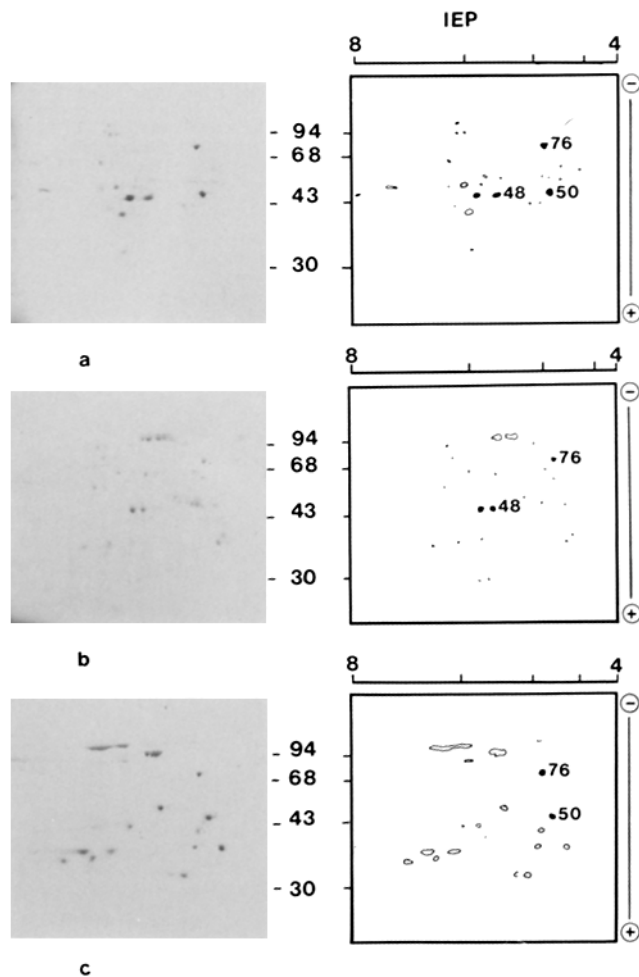

FIGURE 7 Possible identity of some proteins in 15S mRNP and RNA-binding proteins. Two-dimensional gel electrophoresis was performed using the technique described by O'Farrell (39), i.e., isoelectric focusing in the first dimension and 10% SDS gel electrophoresis in the second dimension. First dimension gels contained 8 M urea and 2% ampholines pH 3.5–10. (a) Proteins of 15S mRNP. (b) BP350. (c) BP1000. The gels were stained with Coomassie Blue.

polyribosomal 15S mRNP, but not deproteinized globin mRNA, can be translated. This finding clearly shows that polyribosomal 15S mRNP contains translation factor activity. Our observation that the stimulation by 15S mRNP is recognized only in lysates depleted of RNA-binding proteins, but not in untreated lysates, provides a likely explanation for the failure of previous attempts (11–15) to demonstrate a role for mRNP proteins in translation. Obviously, if a cell-free translation system is saturated with all of the necessary factors in soluble form, it will not be affected by the factors already present in added mRNP.

The existence of proteins with translation factor activity in 15S mRNP and in the cytosol suggests that there is an exchange between these fractions. Such an exchange would be expected to occur if the proteins cyclically associate with and dissociate from mRNA in the course of translation. Indeed, an exchange between mRNP proteins and free proteins has been directly demonstrated by the metabolic studies of Auerbach and Pederson (27) and by Greenberg (28, 29). The active principles with affinity for mRNA have so far been resolved into two fractions of different qualities. The stimulating activity of the less tightly bound BP350 fraction suggests that it includes initiation factors. In fact, as we and others have recently reported, RNA-binding proteins have initiation factor properties (32, 40, 41). Some initiation factors, such as eIF-2, -3, and -4B have affinities for mRNA (42–45). They are more loosely bound and have been routinely isolated by washing ribosomes with 0.5 M KCl (46–48). It is also known that some of them are released after the ribosomal 80S initiation complex has formed (42). In addition, other factors, functioning on the cap end, the poly(A) sequence or elsewhere are possibly involved and may be supplied by the cytosol. Therefore, 15S mRNP from 0.5 M KCl- and EDTA-treated polyribosomes may not contain all of the factors required for efficient translation *in vitro*. Moreover, it is possible that the mRNP fraction has all of the factors needed, but not in sufficient amounts, since addition of BP350 further stimulated translation. The inhibition of 15S mRNP translation caused by BP1000 may be due to a supraoptimal concentration of one or more of the factors present in BP1000.

A preliminary analysis of the proteins of 15S mRNP, of BP350, and of BP1000 suggests that these three fractions share several proteins with isoelectric points in the range between 7.8 and 5.3. We are currently exploring how they interact with globin mRNA. UV-induced cross-linking experiments revealed that, in L-cells, proteins of the same size classes as marked in Fig. 7 are located in "zero distance" to mRNA (49, 50). Clearly, more work is also needed to characterize each of these proteins and demonstrate their specific role in translation.

All correspondence and reprint requests should be addressed to B. Setyono at address on the title page.

Received for publication 21 October 1981, and in revised form 18 January 1982.

REFERENCES

- Perry, R. P., and D. E. Kelley. 1968. Messenger RNP protein complexes and newly synthesized ribosomal subunits: analysis of free particles and components of polyribosomes. *J. Mol. Biol.* 35:37–59.
- Infante, A. A., and M. Nemer. 1968. Heterogeneous ribonucleoprotein particles in the cytoplasm of sea urchin embryos. *J. Mol. Biol.* 32:543–565.
- Henshaw, E. C. 1968. Messenger RNA in rat liver polyribosomes: evidence that it exists as ribonucleoprotein particles. *J. Mol. Biol.* 36:401–411.
- Spirin, A. S. 1969. Informosomes. *Eur. J. Biochem.* 10:20–35.
- Spohr, G., N. Granboulan, C. Morel, and K. Scherrer. 1970. An investigation of free and polyribosome bound cytoplasmic ribonucleoprotein particles by kinetic labelling and electron microscopy. *Eur. J. Biochem.* 17:296–318.

6. Liautard, J. P., B. Setyono, E. Spindler, and K. Köhler. 1976. Comparison of proteins bound to the different functional classes of messenger RNA. *Biochim. Biophys. Acta.* 425:373-383.
7. Greenberg, J. R. 1975. Messenger RNA metabolism of animals cells. Possible involvement of untranslated sequences and mRNA-associated proteins. *J. Cell. Biol.* 65:269-288.
8. Preobrazhensky, A. A., and A. S. Spirin. 1978. Informosomes and their protein components: the present state of knowledge. *Prog. Nucleic Acid Res. Mol. Biol.* 21:1-37.
9. Jeffery, W. R. 1977. Characterization of polypeptides associated with messenger RNA and its polyadenylate segment in Ehrlich ascites messenger ribonucleoprotein. *J. Biol. Chem.* 252:3525-3532.
10. Greenberg, J. R. 1977. Isolation of messenger ribonucleoproteins in cesium sulfate density gradients: evidence that polyadenylated and non-polyadenylated messenger RNAs are associated with protein. *J. Mol. Biol.* 108:403-416.
11. Chen, J. H., G. C. Lavers, and A. Spector. 1976. Calf lens messenger ribonucleoprotein complexes characterization and comparison of template activity with corresponding mRNAs. *Biochim. Biophys. Acta.* 418:39-51.
12. Nudel, U., B. Lebleu, T. Zehavi-Willner, and M. Revel. 1973. Messenger ribonucleoprotein and initiation factors in rabbit reticulocyte polyribosomes. *Eur. J. Biochem.* 33:314-322.
13. Jacobs-Lorena, M., and C. B. Baglioni. 1973. Synthesis of rabbit globin by reticulocyte postribosomal supernatant and heterologous ribosomes. *Eur. J. Biochem.* 35:559-565.
14. Hendrick, D., W. Schwarz, S. Pitzel, and H. Tiedemann. 1974. Messenger ribonucleoprotein directed globin synthesis in an embryonic brain cell-free system. *Biochim. Biophys. Acta.* 340:278-284.
15. Ernst, V., and H. Arnstein. 1975. Synthesis of α and β globin directed by messenger ribonucleoprotein from rabbit reticulocytes. *Biochim. Biophys. Acta.* 378:251-259.
16. Girard, M., and D. Baltimore. 1966. The effect of HeLa cell cytoplasm on the rate of sedimentation of RNA. *Proc. Natl. Acad. Sci. U. S. A.* 56:999-1002.
17. Baltimore, D., and A. S. Huang. 1970. Interaction of HeLa cell proteins with RNA. *J. Mol. Biol.* 47:263-273.
18. Kumar, A., and T. Pederson. 1975. Comparison of proteins bound to heterogeneous nuclear RNA and messenger RNA in HeLa cells. *J. Mol. Biol.* 96:353-365.
19. Lebleu, B., G. Marbaix, G. Heuz, J. Temmerman, A. Burnay, and H. Chantrenne. 1971. Characterization of the messenger ribonucleoprotein released from reticulocyte polyribosomes by EDTA treatment. *Eur. J. Biochem.* 19:264-269.
20. Kumar, A., and U. Lindberg. 1972. Characterization of messenger ribonucleoprotein and messenger RNA from KB cells. *Proc. Natl. Acad. Sci. U. S. A.* 69:681-685.
21. Morel, C., E. S. Gander, M. Herzberg, J. Dubochet, and K. Scherrer. 1973. The duck globin messenger ribonucleoprotein complex resistance to high ionic strength, particle gel electrophoresis composition and visualization by dark field electron microscopy. *Eur. J. Biochem.* 36:455-464.
22. Lindberg, U., and B. Sundquist. 1974. Isolation of messenger ribonucleoproteins from mammalian cells. *J. Mol. Biol.* 86:451-468.
23. Gander, E. S., R. B. Mueller, S. Goldenberg, and C. Morel. 1975. EDTA and puromycin derived duck and rabbit globin messenger ribonucleoprotein complexes isolated by oligodeoxy-thymidine cellulose chromatography. *Mol. Biol. Rep.* 2:343-349.
24. Mayrand, S., B. Setyono, J. R. Greenberg, and T. Pederson. 1981. Structure of nuclear ribonucleoprotein. Identification of protein in contact with poly(A) + heterogeneous nuclear RNA in living HeLa cells. *J. Cell. Biol.* 81:380-384.
25. Mayrand, S., and T. Pederson. 1981. Nuclear ribonucleoprotein particles probed in living cells. *Proc. Natl. Acad. Sci. U. S. A.* 70:2208-2212.
26. Wagenmakers, A. J. M., R. J. Reinders, and W. J. van Venrooij. 1980. Crosslinking of mRNA to proteins by irradiation of intact cells with ultraviolet light. *Eur. J. Biochem.* 112:323-330.
27. Auerbach, S., and T. Pederson. 1975. Metabolic stability of messenger ribonucleoprotein in HeLa cells. *Biochim. Biophys. Acta.* 395:388-391.
28. Greenberg, J. R. 1981. The polyribosomal mRNA protein complex is a dynamic structure. *Proc. Natl. Acad. Sci. U. S. A.* 78:2923-2926.
29. Greenberg, J. R., and B. Setyono. 1981. Messenger ribonucleoproteins, their composition, metabolic properties, and relationship to nuclear ribonucleoproteins as investigated by RNA-protein crosslinking. *Biol. Cell.* 41:67-78.
30. Setyono, B., M. Grossmann, and J. P. Liautard. 1977. Evidence that proteins bound to the polysomal messenger RNA exist also free in the cytoplasm of the HeLa cells. *Biochimie (Paris).* 59:43-49.
31. Setyono, B. 1979. Regulation der Proteinsynthese durch Cytosolproteine, die Affinität zu mRNA haben (RNA-Bindungsproteine). Ph.D. Thesis, University of Stuttgart.
32. Setyono, B., H.-P. Schmid, and K. Köhler. 1979. The role of acidic proteins from cytoplasmic fractions of Krebs II ascites cells for efficient translation. *Z. Naturforschung.* 34c:64-75.
33. Mazur, G., and A. Schweiger. 1978. Identical properties of an mRNA bound protein and a cytosol protein with high affinity for polyadenylate. *Biochem. Biophys. Res. Commun.* 80:39-45.
34. Ovchinnikov, L. P., A. T. Avanesov, T. A. Seriakova, A. T. Alzhanova, and H. M. Radzhabov. 1978. A comparison of the RNA-binding proteins with the proteins of polyribosomal messenger ribonucleoproteins in rabbit reticulocytes. *Eur. J. Biochem.* 90:527-535.
35. Lee, G. T. Y., and D. L. Engelhardt. 1979. Peptide coding capacity of polysomal and non-polysomal messenger RNA during growth of animals cells. *J. Mol. Biol.* 129:221-233.
36. Perry, R. P., J. LaTorre, D. E. Kelley, and J. R. Greenberg. 1972. On the lability of poly(A) sequences during extraction of messenger RNA from polyribosomes. *Biochim. Biophys. Acta.* 262:220-226.
37. Laemmli, U. K. 1970. Cleavage of structure proteins during the assembly of the head of bacteriophage T4. *Nature (Lond.)* 227:680-685.
38. Bonner, W. M., and R. A. Laskey. 1974. A film detection method for tritium labeled proteins and nucleic acids in polyacrylamide gels. *Eur. J. Biochem.* 46:83-88.
39. O'Farrell, P. H. 1975. Resolution two-dimensional electrophoresis of proteins. *J. Biol. Chem.* 250:4007-4021.
40. Vlasik, T. N., L. P. Ovchinnikov, K. M. Radzhabov, and A. S. Spirin. 1978. Translation factors of the wheat embryo extract are RNA-binding proteins. *FEBS (Fed. Eur. Biochem. Soc.) Lett.* 88:18-20.
41. Ovchinnikov, L. P., A. S. Spirin, B. Erni, and T. Staehelin. 1978. RNA-binding proteins of rabbit reticulocytes contain the two elongation factors and some of the initiation factors of translation. *FEBS (Fed. Eur. Biochem. Soc.) Lett.* 88:21-26.
42. Benne, R., and J. W. B. Hershey. 1978. The mechanism of action of protein synthesis initiation factors from rabbit reticulocytes. *J. Biol. Chem.* 253:3078-3087.
43. Trachsel, H., B. Erni, M. H. Schreier, and T. Staehelin. 1977. Initiation of mammalian protein synthesis; the assembly of the initiation complex with purified initiation factors. *J. Mol. Biol.* 116:755-767.
44. Hellerman, J. G., and D. A. Shafritz. 1975. Interaction of Poly(A) and mRNA with eukaryotic initiator Met-tRNA_i binding factor: identification of this activity on reticulocyte ribonucleic acid protein particles. *Proc. Natl. Acad. Sci. U. S. A.* 72:1021-1025.
45. Kaempfer, R., J. van Emmelo, and W. Fiers. 1981. Specific binding of eukaryotic initiation factor-2 to satellite tobacco necrosis virus RNA at a 5'-terminal sequence comprising the ribosome binding site. *Proc. Natl. Acad. Sci. U. S. A.* 78:1542-1546.
46. Schreier, M. H., B. Erni, and T. Staehelin. 1977. Initiation of mammalian protein synthesis. Purification and characterization of seven initiation factors. *J. Mol. Biol.* 116:727-753.
47. Benne, R., M. L. Brown-Luedi, and J. W. B. Hershey. 1978. Purification and characterization of protein synthesis initiation factors eIF-1, eIF-4c, eIF-4D and eIF-5 from rabbit reticulocytes. *J. Biol. Chem.* 253:3070-3077.
48. Trachsel, H., B. Erni, M.H. Schreier, L. Braun, and T. Staehelin. 1979. Purification of seven protein synthesis initiation factors from Krebs II ascites cells. *Biochim. Biophys. Acta.* 561:484-490.
49. Greenberg, J. R. 1980. Proteins crosslinked to messenger RNA by irradiating polyribosomes with ultraviolet light. *Nucleic Acids Res.* 8:5685-5701.
50. Setyono, B., and J. R. Greenberg. 1981. Proteins associated with poly(A) and other regions of mRNA and hnRNA molecules as investigated by crosslinking. *Cell.* 34:775-783.
51. Grierson, D., and V. Hemleben. 1977. Ribonucleic acid from the higher plant *Matthiola incana*. Molecular weight measurements and DNA-RNA hybridization studies. *Biochim. Biophys. Acta.* 475:424-436.