

EXPERIMENTAL ALTERATION OF COUPLING RESISTANCE AT AN ELECTROTONIC SYNAPSE

Y. ASADA and M. V. L. BENNETT

From the Department of Anatomy and the Rose Fitzgerald Kennedy Center for Research in Mental Retardation and Human Development, Albert Einstein College of Medicine, Yeshiva University, New York 10461. Dr. Asada's present address is the Department of Neuropsychiatry, Osaka University Medical School, Asahi-Machi, Abenoku, Osaka, Japan.

ABSTRACT

Adjacent segments of the septate axon of the crayfish *Procambarus* are electrotonically coupled by junction located in the septa between them (see Pappas et al. 1970. *J. Cell Biol.* 49:173). The coupling resistance at the septa was changed by several experimental treatments. Mechanical injury to an axon increased coupling resistance (more than 7-fold); no recovery of coupling resistance was observed, although the resting potential and resistance of the injured axon could return to near normal levels. Immersion in salines with Na propionate substituted for NaCl increased coupling resistance (mean: 6.1-fold). On return of the preparation to normal saline, coupling resistance recovered virtually completely. Immersion in low Ca^{++} solutions moderately increased coupling resistance (3.5-fold or less), but return to normal saline was followed by large increases in coupling resistance (5–100-fold). 60 nM Ca^{++} is near the maximum concentration that leads to increased coupling resistance on return to normal saline. Large increases in coupling resistance are associated with separation of junctional membranes (Pappas et al. 1970. *Ibid.*); calculations show that the separated membranes greatly increase in resistance. Increase in coupling resistance is probably an important response to injury. Mechanisms underlying changes reported here may be relevant to normal physiological processes of coupling and decoupling.

INTRODUCTION

Electrotonic coupling of neurons has been found at numerous sites in both vertebrates and invertebrates (see references 4, 6, and 18), and coupling of cells of smooth and cardiac muscle is also known (2, 3, 11, 17, 33). Furthermore, cells in many inexcitable tissues are coupled (see references 13 and 19), and cells throughout an embryo may be coupled in early stages of development (cf. references 7, 13, and 28). Morphological studies of many instances of electrotonic coupling have disclosed regions where membranes of the coupled cells are very closely apposed compared to the usual intercellular cleft of 200 Å or more (2, 3, 6,

7, 9, 14, 17, 18, 24, 25). This correlation leads to the inference that the close appositions are the sites where current passes between cells, i.e., the electrotonic junctions or synapses. Certain treatments can influence the incidence of these junctions in vertebrate smooth and cardiac muscle, and the changes appear to be associated with appropriate alterations in coupling (2, 3). Although it is difficult in these tissues to measure junctional resistance accurately, support is given to the hypothesis that the close appositions are the electrotonic junctions.

Wherever it has been possible to estimate junc-

tional area and coupling resistance, it has been found that the resistance of junctional membrane is much lower than that of surrounding non-junctional membrane (4, 6). The closeness of apposition is not in itself enough to result in the observed coupling. A problem arises because the measured resistivity of junctional membranes can be sufficiently low for significant coupling to occur even if the cells are separated by a gap of 200 Å or more (5). Thus, although it would appear functional for membranes to be closely apposed at sites of electrotonic coupling, the electrophysiological measurements often do not require it.

The lateral or septate giant axons of the crayfish provide probably the best experimental material available for study of electrotonic coupling between excitable cells. There are two septate axons, one on each side of the nerve cord. They are segmented, and each segment is a separate axon with its own cell body (29, see Fig. 1). Successive segments are closely approximated along an oblique septum in which close appositions are located (14), and where the axons are electrotonically coupled (32). The resistance of junctions in a septum can be accurately measured, and a particular septum studied electrophysiologically can later be subjected to ultrastructural analysis by electron microscopy. Dye experiments indicate that the cytoplasm of adjacent segments are connected by channels separate from the extracellular space (25). The only possible location for these channels is at the close appositions in the septum. The same channels presumably mediate intercellular movement of small ions, and it can be concluded that the close appositions are indeed the sites of electrotonic coupling.

This paper and its companion (23) concern the septate axon and three treatments that increase coupling resistance and also cause separation of the junctional membranes. Mechanical injury to the axon away from the junctional region causes an irreversible increase in coupling resistance. Substitution of several impermeant anions for Cl^- increases coupling resistance, and there is recovery on return to normal physiological saline. Soaking in low Ca^{++} solutions increases coupling resistance only moderately, but on return to solutions with normal Ca^{++} concentration, coupling resistance can increase greatly. This first paper describes the electrical measurements, and the second describes the associated morphological changes. Preliminary

reports of some of this material have been given (1, 22).

METHODS

The crayfish, *Procambarus*, was used in these experiments. Animals were obtained from suppliers in Louisiana and California. The abdominal portion of the ventral nerve cord was dissected out as described by Watanabe and Grundfest (32). The isolated cord was mounted in a Lucite chamber (E. I. du Pont de Nemours & Co., Inc., Wilmington, Del.) in which were fixed pairs of silver wire electrodes for external stimulation. The left axon in the second abdominal ganglion was studied in most experiments. Stimulating and recording equipment were conventional. The experiments were done at room temperature (18–23°C).

Glass capillary microelectrodes filled with 3 M KCl were usually employed for intracellular recording and application of polarizing currents. For most experiments performed in low Cl^- solution, microelectrodes were filled with 3 M K propionate, 3 M K acetate, or 2 M K citrate. No differences were observed in the results obtained with the different electrodes. Electrical resistance of the electrodes ranged from 8 to 20 MΩ. The normal saline used was that of Van Harrevelde (31), which contains 207.5 mM NaCl, 5.4 mM KCl, 13.5 mM CaCl_2 , and 2.6 mM MgCl_2 . The saline was buffered at pH 7.4 with Tris ([tris hydroxymethyl] amino methane), approximately 5 mM.

A ganglion with axonal segments on the left side, the experimental arrangement, and the equivalent circuit are diagrammed in Fig. 1. In the most complete experiments, four electrodes were inserted close together, two on each side of the septum. The farthest apart of the four were separated by 0.2–0.3 mm. One electrode on each side of the septum was used for recording potential and the other was used for passing current. Propagated action potentials were evoked by stimuli applied to the nerve cord several millimeters away on either side of the septum. The space constant of these axons is quite long, and the potential across the septum is nearly constant along its length (32). Thus, junctions in the septum may be treated as a single lumped resistance, R_s , coupling the cytoplasm of two axonal segments. Some leak to the extracellular space from between the junctional membranes cannot be excluded by the electrical measurements (4, 5). However, as already noted, dye experiments indicate that there are channels connecting the cell cytoplasm that do not open to extracellular space (25). The input resistances looking down each segment away from the septum, i.e. excluding current through the junctions in the septum, can also be treated as single values R_1 and R_2 for the rostral and caudal

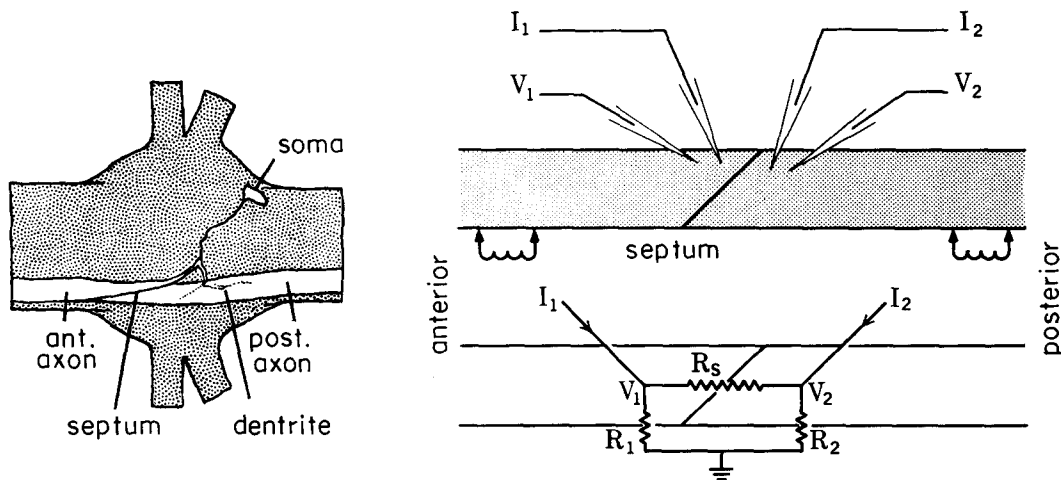

FIGURE 1 Diagram of an abdominal ganglion, electrode placement, and equivalent circuit. A dorsal view of a ganglion with its two pairs of segmental nerves is shown on the left. The left axonal segments are diagrammed, including the soma and main dendritic arborization of the anterior axon (modified from reference 29). The dendrite lies ventral to the anterior end of the posterior axon. Placement of electrodes with respect to the septum is diagrammed on the upper right. The equivalent circuit is on the lower right.

segments, respectively. These resistances would include current entering the extracellular space from the nonjunctional membrane that occupies most of the septal area (23). The equivalent circuit of the system is that shown in Fig. 1, right. To determine the resistances, several hyperpolarizing pulses ranging from 20 to 100 na were applied on each side of the septum. The values of R_1 , R_2 , and R_s were then calculated from measured input and transfer resistances, by using the standard te-pi transformation of circuit theory (4). (Input resistance is the ratio of voltage in one cell to current applied in the same cell; transfer resistance is the ratio of voltage in one cell to current applied in the other cell.) For hyperpolarizations of less than about 50 mv, all the resistances are fixed and do not rectify. In this region the two transfer resistances must be equal (4), and ordinarily only one was measured. R_1 , R_2 , and R_s are used to describe the initial values and, provided ambiguity is not likely to arise, the values as they change during experimental treatments. Where comparisons are made, initial values are unprimed; values after experimental treatments are primed; and values after return to control conditions are doubly primed.

In some experiments the current electrode was omitted on the caudal side of the septum. This simplification greatly facilitated the procedure because of the presence of connective tissue on the caudal side. The fourth electrode was omitted only when prior experiments indicated that both axonal resistances were affected equally by the given experimental treatment and that R_1 and R_2 could be

taken as equal. The assumption of equality of R_1 and R_2 must have introduced some error into the calculation of R_s , but could not have been responsible for the observed changes in R_s , nor have greatly affected their magnitude.

The increases in coupling resistance to be described could in principle result from one of the following mechanisms: (a) the resistance of the junctional membranes could increase without change in junctional area, i.e., the area of close membrane apposition; (b) junctional area could be decreased by separation of the junctional membranes without increase in their resistance; or (c) junctional membranes could both separate and increase in resistance. As is shown in the next paper, the increases are associated with separation by several microns of the axonal membranes forming the junctions. The separation turns out to be accompanied by an increase in resistance of the junctional membrane, although this would not be required to explain the increase in junctional resistance because a sufficiently wide cleft is opened to short-circuit current flow between cells (4 and unpublished). The effects of these changes on the electrical measurements may be discussed with respect to Fig. 2. The junctional membrane can be considered to be made up of two areas, of which the *a* area remains together and the *b* area separates during the experimental treatment. Each area consists of two membranes in series which leads to the modified equivalent circuit of the normal septal region in Fig. 2 B. When the junctional membranes separate and the *b* areas open to the extracellular space, the

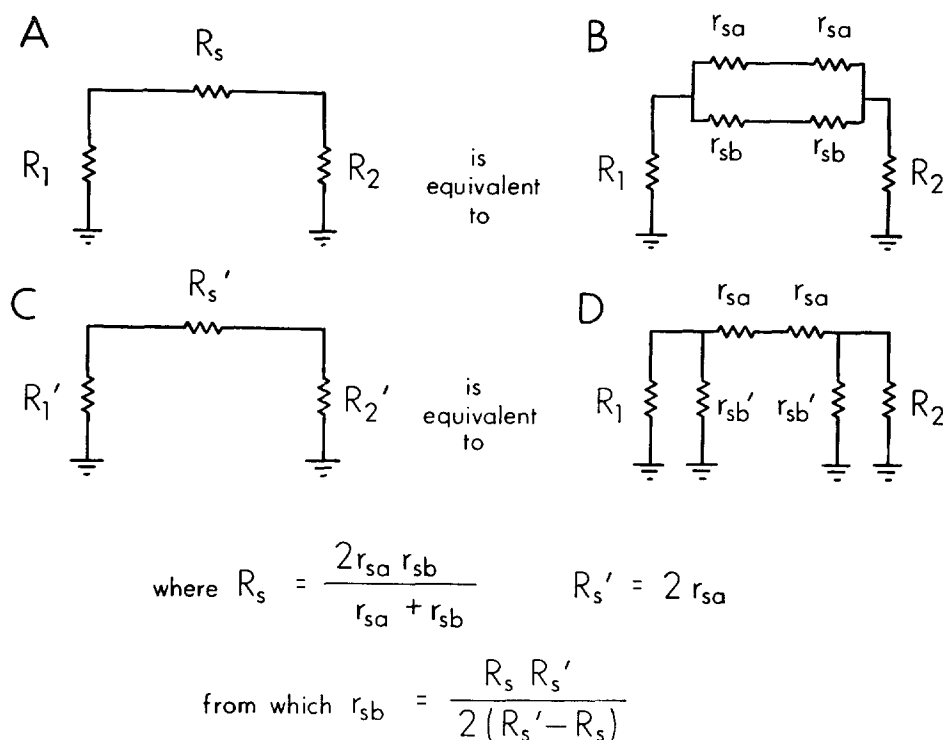

FIGURE 2 Equivalent circuits for separation of junctional membranes. *A*, simplest circuit of initial conditions; *B*, the junctional region is considered to be made up of two membranes in series divided into *a* and *b* areas; *C*, the simplest circuit with altered values after an experimental treatment; *D*, the equivalent circuit if the *b* area of the junction separates widely and acquires a new resistance r_{sb}' while R_1 and R_2 do not change. The equations show the relations between R_s and R_s' , the computed coupling resistances, and r_{sa} and r_{sb} , the resistances of the junctional membranes prior to separation of the *b* areas.

equivalent circuit becomes that in Fig. 2 D, in which it is assumed that the *b* areas acquire a new resistance r_{sb}' and, for simplicity, that R_1 and R_2 are unchanged. The resistances of the separated junctional membranes r_{sb}' are then in parallel with the nonjunctional resistances R_1 and R_2 . The measurements of input and transfer resistance only allow evaluation of the pi equivalent of this new circuit (Fig. 2 C). Furthermore, the spatial resolution of microelectrode measurements will generally be too poor to distinguish current flowing through a separated junctional membrane and through the immediately adjacent nonjunctional membrane. However, as described with respect to the particular experiments, one can generally infer the effects of the experiment on R_1 and R_2 from other evidence, and some statement can be made as to changes in the resistance of the junctional membranes that separate.

One experimental manipulation was deliberate mechanical injury of an axonal segment. In most of these experiments, the connective tissue and

small nerve fibers surrounding the axon were removed as far as possible. It was then possible for one to cut completely through the axon with small scissors without dislodging the microelectrodes. The axon was usually cut 1–2 mm rostral to the septum.

In a second series of experiments the axons were immersed in low Cl^- solutions. In these solutions, sodium chloride in the normal saline was replaced by sodium propionate, acetate, sulphate, isethionate, glycerophosphate, or nitrate, the other constituents being kept constant. Thus, Cl^- was reduced to about $1/4$ th of its normal value.

In the final series of experiments the axons were immersed in solutions low in free Ca^{++} . One type of solution contained 1–2 mM EDTA (disodium ethylenediaminetetraacetate and no Ca^{++}). In other experiments, calcium was buffered at particular values by using methods similar to those described by Portzehl et al. (27). Mg^{++} was omitted in both normal and Ca-buffered salines. The actual concentrations used were (a) 1 mM Ca and 2 mM EDTA which gives a free Ca^{++} value of about 30 nM, and

(b) 1.5 mM Ca and 2 mM EDTA which gives a free Ca^{++} value of about 60 nM. The pH was adjusted to 7.4 with a small amount of Tris buffer (about 5 mM). To minimize pH shifts resulting from interaction between Ca^{++} and EDTA, the normal saline was first replaced with Ca-free saline, and then this solution was replaced by the Ca-buffered saline. The same procedure was employed to return to normal saline. The volume of the chamber was about 10 cc. Several fairly complete exchanges of fluid were made for each change of solution. No more than 2–3 min were required to change solutions.

RESULTS

The Effects of Mechanical Injury

Mechanical injury to an axonal segment caused an increase in coupling resistance at the septum. In the experiment illustrated in Figs. 3 and 4, the rostral axonal segment was completely cut across 1.5 mm from the septum at which the measuring electrodes were placed. Before sectioning, action potentials propagated in both directions across the septum, shown for external stimulation on the caudal side in Fig. 3, *A*. Following sectioning, only a small postjunctional potential was recorded in the rostral segment when the caudal axon was stimulated (Fig. 3, *B*). The resting potentials decreased at the moment of sectioning by 20–25 mv in the sectioned segment and 10–15 mv in the intact segment. Subsequently, the resting potential in the intact segment gradually recovered, but that in the sectioned segment remained 10–15 mv below its initial value. Although the rostral segment no longer supported an all-or-none spike, it remained gradedly responsive. The coupling and axonal resistances were calculated from input and transfer resistances measured before and at various times after sectioning. These results are plotted in Fig. 4, and representative records are shown in Fig. 3, *A'* and *B'*. Following sectioning, a current pulse applied in the intact (caudal) segment caused potentials that were larger in the intact segment and smaller in the sectioned segment compared to the potentials obtained before section. R_s increased after sectioning. On the other hand, R_2 did not change. R_1 decreased immediately after sectioning and then gradually returned to very near its initial value. Healing over of the cut end is suggested from the change in R_1 .

The results of this experiment and three similar ones are shown in Table I (Nos. 1–4). The coupling resistance was increased from 7.5 to 13

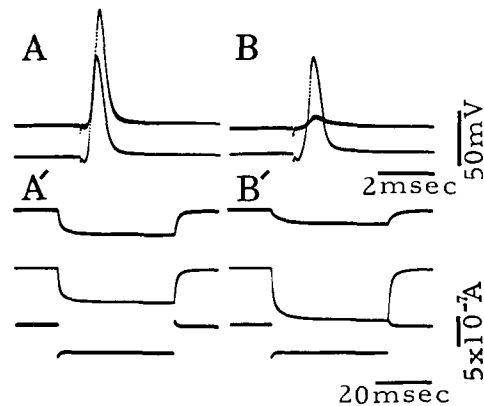

FIGURE 3 Effect of mechanical injury on coupling at the septum. *A* and *A'*, records before injury; *B* and *B'*, records 60 min after cutting through the rostral axon with scissors. In each record the upper trace shows the potential in the rostral segment, and the second trace shows the potential in the caudal segment. Propagated spikes in *A* and *B* were evoked by stimulation of the caudal axon; in *B*, only a small postjunctional potential was recorded in the rostral segment. An equal hyperpolarizing pulse was applied on the caudal side in *A'* and *B'* (3rd traces). The resulting potential was larger on the caudal side and smaller on the rostral side after injury.

times. In all of the experiments the sectioned segment remained at least gradedly responsive. R_2 remained constant to within a few per cent, and R_1 showed decreases easily explained as the direct result of sectioning. In the next paper it is shown that injury causes the junctional membranes to separate. Since it is unlikely that the nonjunctional membrane increased in resistance as a result of sectioning, the lack of change in R_2 indicates that the resistance of the junctional membranes increased greatly when the membranes separated. This point may be understood with reference to Fig. 2. The coupling resistance after injury, R_s' , was much larger than the initial value R_s . Thus, r_{sb} , the resistance of the membranes that separated (but prior to their separation), is approximated by $\frac{1}{2} R_s$, which in each case is less than one-half of R_2 . Since it can be assumed that R_2 was little changed, the near equality of R_2 and R_2' indicates that the resistance of the separated junctional membranes, r_{sb}' , was large compared to R_2 , and that the resistance of these membranes increased at least 50–100-fold when they separated.

In two additional experiments, R_1 , R_2 , and R_s were measured and the electrodes were removed.

TABLE I

Effect of Mechanical Injury on Junctional and Axonal Resistances

For Nos. 1-4 the rostral segment was cut across with scissors and appreciable sealing occurred. For Nos. 5 and 6 the cut end was opened widely and sealing was prevented. All resistances are given in $k\Omega$. The column labeled "Time" gives the intervals in minutes between injury and subsequent resistance measurements.

No.	Before injury			After injury				Time
	R_1	R_2	R_s	R_1'	R_2'	R_s'	R_s'/R_s	
								<i>min</i>
1	95	118	35	90	118	370	11	60
2	100	113	84	90	115	1090	13	70
3	156	195	88	150	192	810	9.2	40
4	150	130	100	90	133	750	7.5	60
5	127	135	120		135			60
6	145	131	134		131			90

The rostral segment was then opened wide by using forceps so that healing over did not occur. Two electrodes were reinserted into the intact segment and the input resistance was measured. In these experiments, the input resistance R_2' virtually equalled R_2 , its initial value, 60-90 min after sectioning (Table I, Nos. 5 and 6). Again, it can be concluded that there was a large increase in the resistance of the separated junctional membranes of the caudal segment.

In all of these experiments, measurements were made at the septum caudal to axonal sectioning. Presumably the rostral septum was similarly affected, because passage of fluorescein across a septum can be blocked by injury to either the rostral or the caudal axonal segment (24).

The Effect of Low Cl^- Solution

When NaCl in normal saline was replaced with sodium propionate, acetate, sulphate, or isethionate, coupling resistance was increased. Data from an experiment involving propionate substitution are shown in Figs. 5 and 6. In normal saline, action potentials propagated across the septum (Fig. 5, *A*), but transmission failed after bathing with propionate saline (Fig. 5, *B*). Following return to normal saline, transmission recovered (Fig. 5, *C*). Equal currents were applied in the rostral segment in *A'*, *B'*, and *C'*. In propionate saline (*B'*), the potential in the rostral segment was increased and the spread across the septum was decreased compared to initial values (*A'*) and recovery in normal saline (*C'*). Fig. 6 shows the changes in calculated resistances during this experiment. Three elec-

trodes were used, but in other experiments propionate substitution equally affected axonal resistance on the two sides of the septum (Table II, Nos. 1-4), and R_1 and R_2 were assumed to be equal throughout the experiment. The coupling resistance R_s increased markedly in propionate saline and returned to its original level in normal saline. On the other hand, R_1 increased relatively little in propionate saline (about 40%) and recovered in normal saline (Table II, No. 8). The times of failure and recovery of impulse propagation across the septum are indicated by the arrows. The results of other experiments with propionate solutions are shown in Table II.

The increase in R_s upon immersion in propionate solutions was always gradual. After about 60 min a maximum was reached which in two experiments (Nos. 9 and 10, Table II) was unchanged for an additional period of 1 or 2 hr. R_s usually decreased to close to its initial value following return to normal saline after immersion for 30-180 min in propionate or acetate saline. In experiment No. 11 (Table II), there was no recovery. Possibly, there was some mechanical injury to the axon during the experimental manipulations. In the ten experiments in which recovery was obtained, R_s in propionate ranged from 2.7 to 12.7 times its control value (mean: 6.2).

The degree of Cl^- substitution required to produce changes in septal resistance was not determined. In four experiments substitution of propionate for about 50% of the Cl^- had about the same effect as the more complete substitutions (Nos. 1-4, Table II).

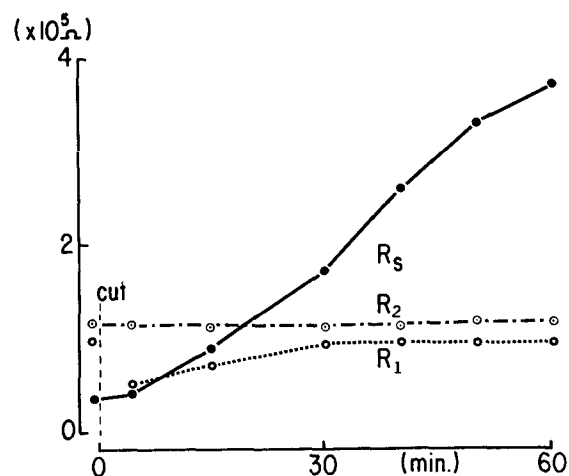

FIGURE 4 Time course of resistance changes following mechanical injury. Values of R_1 , R_2 , and R_s are graphed. The ordinate is resistance; the abscissa is time after section. Same experiment as Fig. 3 and No. 1 in Table I.

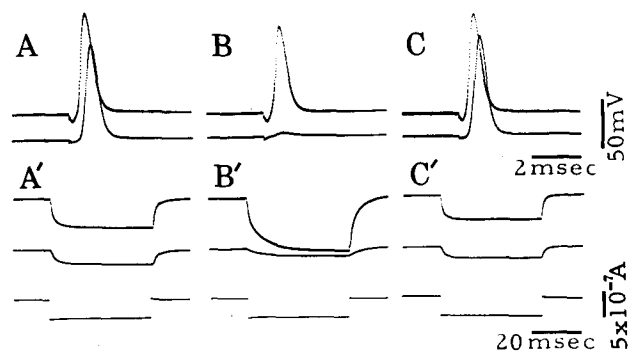

FIGURE 5 Effect of propionate saline on coupling at the septum. *A* and *A'*, records in normal saline; *B* and *B'*, records 60 min after immersion in saline in which NaCl was replaced by propionate; *C* and *C'*, records 75 min after return to normal saline. Display and stimulation are as in Fig. 3, except that the propagated spike was evoked by stimulation of the rostral segment and the current pulses were applied on the rostral side, only a recording electrode being on the caudal side. Propagation across the septum was blocked in *B* and recovered in *C*. A fixed hyperpolarizing pulse produced a larger potential on the rostral side and a smaller potential on the caudal side when the preparation was in propionate (*B'*) as compared to when it was in normal saline (*A'* and *C'*).

As is shown in the next paper, the increases in coupling resistance in the propionate solutions were associated with separation of the junctional membranes. The calculated values for r_{sb} , the resistance of the junctional membranes that separated, but prior to their separation, were obtained according to the equivalent circuit and equations of Fig. 2. These values were always considerably smaller than the measured values of R_1' , and it can be concluded that the resistance of the separated junctional membranes must have

increased manifold. The amount of increase cannot be determined because of uncertainty about the amount of increase of the axonal resistances in the propionate solutions.

The increase in the nonjunctional resistance suggests that the septate axons are significantly permeable to Cl^- (30). In two experiments with propionate saline, the space constant λ was observed to increase by about the same amount as the axonal resistances, R_1 and R_2 . Since $\lambda = \sqrt{r_m/r_i}$ and $R_{in} = \frac{1}{2} \sqrt{r_m r_i}$ in a uniform axon,

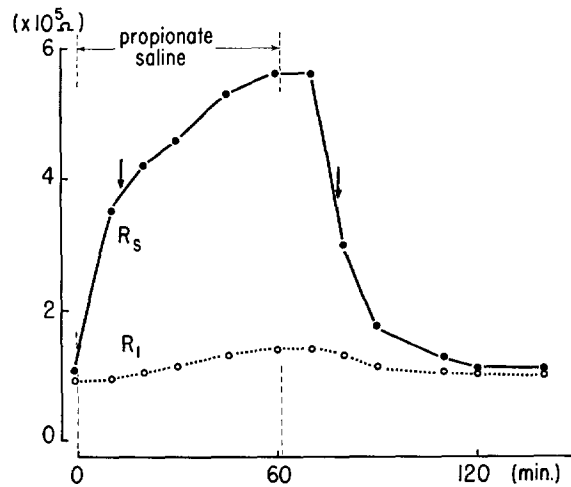

FIGURE 6 Time course of resistance changes during and after immersion in propionate saline. Values were computed on the assumption that R_1 and R_2 were equal. The arrows indicate the times at which impulses failed to propagate across the septum. Same experiment as Fig. 5 and No. 8 of Table II.

both changes are ascribable to increase in membrane resistance with little change in axoplasmic resistance.

The presence of an appreciable Cl^- permeability is confirmed by the transient decrease in amplitude of propagated spikes when the axons were immersed in the propionate solutions. The amplitude reached a minimum of 70–90% of normal after about 10 min, and over the next 20 min recovered to a fairly stable value of 85–95% of normal (Fig. 5, *B*). Following return to normal saline, the spike amplitude usually recovered its initial value within 15 min (Fig. 5, *C*). The transient decrease in spike amplitude suggests that there is a transient decrease in resting potential that is probably due to efflux of Cl^- .

In two experiments, three recording electrodes were inserted into the same axonal segment and removed one at a time to determine the resting potentials in normal saline, in propionate saline, and after return to normal saline. After 40 min in propionate saline, the resting potential was decreased by only a few millivolts, and on return to normal saline there was virtually complete recovery.

The small depolarization maintained in propionate solution does not appear adequate to explain the concomitant decrease of spike amplitude of about 10% and it is likely that there is an additional effect of propionate solutions. In agreement with this hypothesis, after 2–3 hr in these

solutions the axons began to depolarize further and irreversibly.

A limited number of experiments were carried out with other Cl^- substituents. Two experiments with acetate saline gave results similar to those obtained when propionate was substituted for Cl^- . The time course of the calculated resistances in one of these experiments is shown in Fig. 7. The increase in R_s in this experiment was the greatest observed in the experiments involving low Cl^- solutions. Isethionate and sulphate salines caused moderate increases of junctional resistance, but recovery to initial values did not occur (Nos. 14–18). When glycerophosphate or nitrate was used to replace chloride, no change of coupling resistance was obtained (Nos. 19–22). All the substituents that increased coupling resistance had similar effects on the amplitude of propagated spikes.

The Effect of Low Ca^{++} Solutions

Coupling resistance was affected by immersion in low Ca^{++} solutions. The effects of a solution in which Ca^{++} was buffered to a value of about 30 nM are shown in Figs. 8 and 9. Normal transmission across the septum is shown in Fig. 8, *A*. Propagated action potentials were blocked in the low Ca^{++} solution (Fig. 8, *B*). The action potentials recovered after 10–20 min in normal saline, but transmission across the septum failed in both directions (Fig. 8, *C*). Equal current pulses were

TABLE II
Effect of Low Cl⁻ Solutions on Junctional and Axonal Resistances

NaCl was completely replaced by the sodium salt of the indicated anion except in Nos. 1-4, in which there was 50% replacement. All resistances in kΩ. The column labeled "Time" gives the intervals in minutes between solution changes and subsequent resistance measurements.

No.	Substitute anion	Normal saline			Substituted saline			Normal saline after			Time	min	
		R ₁	R ₂	R _s	R ₁ '	R ₂ '	R _s '	R _s /R _s	R ₁ "	R ₂ "			R _s "
1	Propionate	125	135	56	158	165	200	3.6	143	160	60	1.1	60
2		110	97	35	140	130	210	6.0	135	120	41	1.2	60
3		81	121	86	94	142	320	3.7	85	126	85	1.0	60
4		141	130	55	157	145	370	6.7	141	127	58	1.1	60
5		135		61	167		710	11.6	135		61	1.0	50
6		120		80	170		230	2.9	120		100	1.2	40
7		120		130	145		410	3.2	130		180	1.4	70
8		94		110	140		560	5.1	100		114	1.0	80
9		92		31	160		210	6.8	110		35	1.1	90
10		92		44	190		560	12.7	140		47	1.1	80
11		92		59	125		1000	17.0	120		1700	29	50
12	Acetate	123	170	76	140	192	220	2.9	125	174	81	1.1	60
13		180		82	225		2100	25.6	180		83	1.0	120
14	Isethionate	144		96	148		220	2.3	140		265	2.8	40
15		140	210	53	160	220	187	3.5	150	210	190	3.6	40
16		116		38	150		91	2.4	162		98	2.6	60
17	Sulphate	85		119	86		278	2.4	108		314	2.6	50
18		106		100	126		370	3.7	155		490	4.9	60
19	Glycerophosphate	200	130	40	180	100	40	1.0	260	170	41	1.0	60
20		104		50	100		50	1.0	104		58	1.2	60
21	Nitrate	84		150	92		170	1.1	110		180	1.2	50
22		80		90	90		90	1.0	106		95	1.1	50

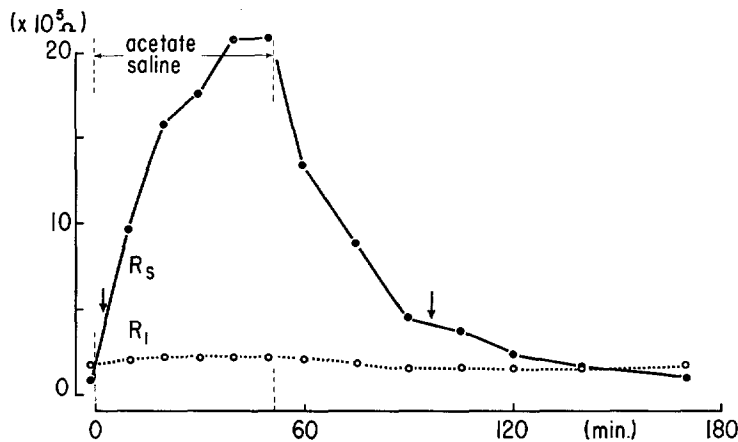

FIGURE 7 Time course of resistance changes during and after immersion in acetate saline. Display as in Fig. 6. The acetate saline was identical to normal saline except that NaCl was replaced with Na acetate. Same experiment as No. 13 of Table II.

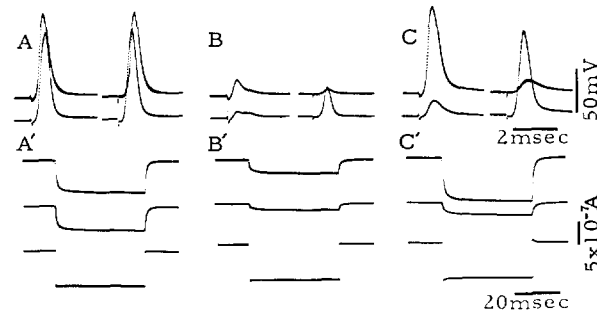

FIGURE 8 Effect of 30 nM Ca^{++} on coupling at the septum. *A* and *A'*, records in normal saline; *B* and *B'*, records 30 min after immersion in 30 nM Ca^{++} solution; *C* and *C'*, records 30 min after return to normal saline. Display is as in Fig. 3, except that in *A*, *B*, and *C*, the first half of the record shows the response to stimulation on the rostral side and the second half of the record shows the response to stimulation on the caudal side. Impulse activity became greatly attenuated in low Ca^{++} (*B*). Impulses recovered in normal saline, but failed to propagate across the septum (*C*). In low Ca^{++} a fixed current pulse applied on the rostral side produced smaller potentials in both rostral and caudal segments (*B'*) than were initially obtained in normal saline (*A'*). After return to normal saline the potentials became larger on the rostral side and smaller on the caudal side (*C'*) than they were initially in normal saline (*A'*).

applied in the rostral segment in *A'*, *B'*, and *C'*. Potentials on both rostral and caudal sides were considerably decreased in low Ca^{++} solution (*B'*). Following return to the normal saline, the potential on the rostral side was increased to greater than the control value, but the postjunctional potential was markedly reduced, changes which indicate an increase in coupling resistance. The calculated resistances during this experiment are shown in Fig. 9. There was a slight increase in R_s and a much greater decrease in R_1 and R_2 in low Ca^{++} solution. Following return to normal

saline, there was a rapid and marked increase in R_s , while R_1 and R_2 gradually recovered to near their original levels. All-or-none spikes could be evoked after about 15 min.

The results for other experiments with low Ca^{++} solutions are shown in Table III. The time courses of the resistance changes and of changes in the spikes were in general similar to those in the experiment illustrated in Figs. 8 and 9. There were no marked differences in the effects of the different solutions on R_1 and R_2 . Small increases in R_s were obtained in the buffered Ca^{++} solutions. In 2 mM

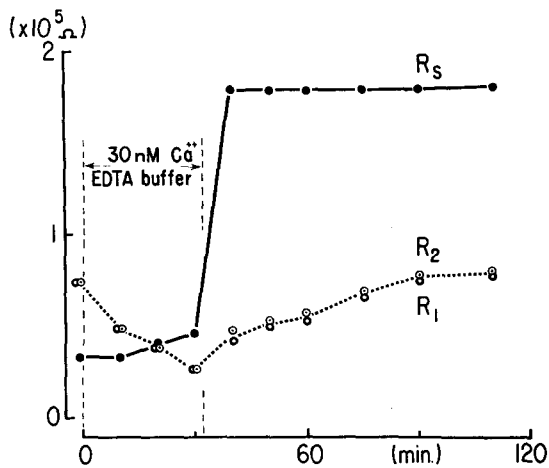

FIGURE 9 Time course of resistance changes during and after immersion in 30 nM Ca^{++} solution. The same experiment as in Fig. 8 is shown. Open circles, R_1 ; dotted circles, R_2 ; filled circles, R_s .

EDTA solutions, R_s increased about 3-fold over the control values, about one-half the increase seen on the average in propionate saline. Following return to normal saline from 30 nM Ca^{++} or EDTA solutions, the increases in R_s could be very large. The increases in normal saline were smaller after 60 nM Ca^{++} treatment. (There are no overlapping values between the data for 30 nM and 60 nM Ca^{++} , which by the Mann-Whitney U test is significant at the 0.03 level). It is likely that 60 nM Ca^{++} is near the maximum concentration that will lead to increased resistance following return to normal saline.

The Ca^{++} concentration required for increase in coupling resistance after treatment with low Ca^{++} solutions has not been adequately determined. In two experiments (Nos. 7 and 12) the axon was placed in 1 mM Ca^{++} for 30 min between immersion in low Ca^{++} solution and return to normal saline. In each case, R_s increased in 1 mM Ca^{++} to over one-half the value it finally reached in normal saline, although the change was much greater after 30 nM Ca^{++} than after 60 nM Ca^{++} . (R_s increased to 345 k Ω for No. 7 and to 50 k Ω for No. 12). The nonjunctional resistances continued to decrease in 1 mM Ca^{++} or were unchanged (R_1 and R_2 became 31 k Ω and 33 k Ω for No. 7, and R_1 remained at 27 k Ω for No. 12). In one experiment (No. 8) the axon was placed for 30 min in approximately 1 μM Ca^{++} after immersion

in 30 nM Ca^{++} . In this experiment, R_s also increased (to 360 k Ω), while there was little change in R_1 . These data, although incomplete, suggest that maximum increase in coupling resistance requires return to near normal Ca^{++} concentrations, but that substantial increases can be obtained at concentrations well below normal.

The morphological results reported in the next paper indicate that the increases in R_s during immersion in low Ca^{++} solutions were not associated with separation of the junctional membranes, while on return to normal saline the membranes did separate. The separated junctional membranes must have greatly increased their resistance in normal saline, for the nonjunctional resistance returned to near normal values (cf. Table III and Fig. 2). Although there appears to be little junctional separation during low Ca^{++} treatment, the electrical measurements were usually compatible with simple separation of the junctional membranes accompanied by no change, or moderate increases, in their resistance. There is considerable uncertainty in the calculations because of changes in nonjunctional resistance. In several experiments the space constant was approximately halved in low Ca^{++} solution, indicating an approximate halving of nonjunctional resistance.

DISCUSSION

We have shown increases of coupling resistance in three types of experiment. With the exception of the moderate increases in low Ca^{++} solutions, these changes are accompanied by separation of the junctional membranes as is reported in the next paper (23). The electrical measurements indicate that the resistance of the separated junctional membranes is greatly increased. One possible sequence is that the increase in junctional resistance precedes and perhaps causes separation of the membranes. Alternatively, the separation of the membranes may be the initial step which is then followed by increase in resistance. Evaluation of the possibilities is aided by a consideration of the structure of the junctional complex, and will be deferred until the next paper.

Whatever is the mechanism whereby injury increases coupling resistance, the response could be a very useful one to the crayfish. If an axon segment is injured, it becomes disassociated from its neighbors, thereby reducing injury currents and perhaps also allowing the synaptic regions in the adjacent segments to function normally.

TABLE III
Effect of Low Ca^{++} Solutions on Junctional and Axonal Resistances

Test solutions were made up and applied as indicated in the Methods. All resistances in $k\Omega$. The column labeled "Time" gives the interval in minutes between solution changes and subsequent resistance measurements.

No.	Test solution	Normal saline			Low Ca^{++} solution					Normal saline, after				
		R_1	R_2	R_s	R_1'	R_2'	R_s'	R_s'/R_s	Time	R_1''	R_2''	R_s''	R_s''/R_s	Time
1	2 mM EDTA	99	114	26	17	33	90	3.5	30	117	120	1200	46	60
2	"	60	120	62	28	56	169	2.7	30	94	2800	100	40	40
3	"	84		28	29		62	2.2	30					
4	"	92		85	27		270	3.2	30	109	440	11	60	60
5	1 mM EDTA	100		40	26		67	1.7	30					
6	30 mM Ca^{++}	72	76	34	27	26	40	1.2	30	73	76	180	5.3	80
7	"	95	112	30	56	68	67	2.2	40	74	85	600	20	30
8	"	108		65	47		90	1.4	30	84	1600	25	30	30
9	60 mM Ca^{++}	82	78	31	26	25	43	1.4	30	91	87	100	3.2	70
10	"	80	100	31	24	34	40	1.3	50	87	100	74	2.4	60
11	"	92	98	40	37	34	56	1.4	30	85	109	110	2.8	40
12	"	97		22	27		27	1.2	30	100	62	62	2.8	60
13	"	100		29	43		35	1.2	30					

An interesting question is whether or not an injured axon can become reconnected to its neighbor in vivo. The longevity of crayfish motor axons distal to a section is remarkable, and there is evidence that a regenerating axon may reunite with its severed distal portion (15). In light of these observations, one would expect that recoupling at a septum following injury could be demonstrated in chronic experiments.

Decoupling in response to injury may be a fairly general phenomenon. It has been observed in smooth muscle (3), and the so-called "healing over" of cardiac muscle (11, 12) may be a similar process. Injury leads to decoupling of salivary gland cells of dipterans which are inexcitable (21). Of course, many cells including the septate axon appear to be able to repair a break in the plasma membrane (e.g. references 7 and 20), and injury need not inevitably cause decoupling. In smooth muscle, electrical decoupling is associated with the disappearance of close appositions in the tissue (2). No morphological changes have been noted in the septate desmosomes which connect salivary gland cells (10). However, it is not certain that these are sites of electrical coupling between the cells, and close appositions similar to those found between other coupled cells have been observed between surface membranes of the gland cells (Birgit Rose, personal communication).

The response to injury complicates the interpretation of experiments designed to analyze the mechanism whereby coupling resistance is increased. A treatment may trigger the injury response rather than itself act on the junctional membrane.

The increase in coupling resistance produced by most of the low Cl^- solutions is difficult to understand, and the changes in propionate and acetate are remarkable in their reversibility. Although additional experiments are required, the results with glycerophosphate suggest that the increase in coupling resistance is not initiated by efflux of Cl^- . The absence of an effect of nitrate substitution might be explained by assuming that NO_3^- is able to substitute for Cl^- , and the lack of reversibility of changes in isethionate and $\text{SO}_4^{=}$ suggests that these substituents have a toxic effect. Increase in coupling resistance is not a general effect of propionate substitution, for it is not observed between the Retzius cells of the leech (26), and in cardiac muscle propagation of action potentials is little affected by propionate or other large anions (8, 16).

The most marked effects of low Ca^{++} solutions occur following return to normal Ca^{++} concentrations. One would infer that Ca^{++} is involved in the increase in junctional resistance, but whether it acts directly on the junctional membrane or is involved in some other process such as cell movement remains to be determined.

Whatever the mechanisms of the changes in coupling resistance, the possibility is raised that physiological variables may reversibly or irreversibly alter coupling between cells. The changes in coupling in development appear to be an important example (7, 13, 28). Although the present results may prove to have no relevance to normal interactions between nerve cells, the changes in effectiveness of transmission are as dramatic as any observed at chemically transmitting synapses.

The experimental work on which this report is based was done at the Laboratory of Neurophysiology, College of Physicians and Surgeons, Columbia University, New York, and the Marine Biological Laboratory, Woods Hole, Mass.

We are grateful to Dr. Harry Grundfest for his support of this work, which was also supported in part by grants from the National Institutes of Health (NB-3728, NB3270, 5TI-NB-5328, NB-03448, NB-03313, PO1-NB07512, and HD-04248), the National Science Foundation (GB-6880 and GB-2940), and the Life Insurance Medical Research Fund (G-69-35). Dr. Bennett is a Kennedy Scholar.

Received for publication 6 July 1970, and in revised form 19 October 1970.

REFERENCES

1. ASADA, Y., G. D. PAPPAS, and M. V. L. BENNETT. 1967. Alterations of resistance at an electrotonic junction and morphological correlates. *Fed. Proc.* **26**:330. (Abstr.)
2. BARR, L., W. BERGER, and M. M. DEWEY. 1968. Electrical transmission between smooth muscle cells. *J. Gen. Physiol.* **51**:347.
3. BARR, L., M. M. DEWEY, and W. BERGER. 1965. Propagation of action potentials and the structure of the nexus in cardiac muscle. *J. Gen. Physiol.* **48**:797.
4. BENNETT, M. V. L. 1966. Physiology of electrotonic junctions. *Ann. N. Y. Acad. Sci.* **137**:509.
5. BENNETT, M. V. L., and A. A. AUERBACH. 1969. Calculation of electrical coupling of cells separated by a gap. *Anat. Rec.* **163**:152. (Abstr.)
6. BENNETT, M. V. L., G. D. PAPPAS, M. GIMÉ-

- NEZ, and Y. NAKAJIMA. 1967. Physiology and ultrastructure of electrotonic junctions. IV. Medullary electromotor nuclei in gymnotid fish. *J. Neurophysiol.* **30**:236.
7. BENNETT, M. V. L., and J. P. TRINKAUS. 1970. Electrical coupling between embryonic cells by way of extracellular space and specialized junctions. *J. Cell Biol.* **44**:592.
 8. BENNETT, R. B., and F. WARE. 1966. Effect of several chloride substitutes on transmembrane potentials of frog ventricle. *Fed. Proc.* **25**:517.
 9. BRIGHTMAN, M. W., and T. S. REESE. 1969. Junctions between intimately apposed cell membranes in the vertebrate brain. *J. Cell Biol.* **40**:648.
 10. BULLIVANT, S., and W. R. LOEWENSTEIN. 1969. Structure of coupled and uncoupled cell membrane junctions. *J. Cell Biol.* **37**:621.
 11. DÉLÉZE, J. 1970. The recovery of resting potential and input resistance in sheep heart injured by knife or laser. *J. Physiol. (London)*. **208**:547.
 12. DE MELLO, W. C., G. E. MOTTA, and M. CHAPEAU. 1969. A study of the healing-over of myocardial cells of toads. *Circ. Res.* **24**:475.
 13. FURSHPAN, E. J., and D. D. POTTER. 1968. Low-resistance junctions between cells in embryos and tissue culture. In *Current Topics in Developmental Biology*. A. A. Moscona and A. Monroy, editors. Academic Press Inc., New York. **3**:95.
 14. HAMA, K. 1961. Some observations on the fine structure of the giant fibers of the crayfishes (*Cambarus virilis* and *Cambarus clarkii*) with special reference to the submicroscopic organization of the synapses. *Anat. Rec.* **141**:275.
 15. HOY, R. R., G. D. BITTNER, and D. KENNEDY. 1967. Regeneration in crustacean motoneurons: evidence for axonal fusion. *Science (Washington)*. **156**:251.
 16. HUTTER, O. F., and D. NOBLE. 1961. Anion conductance of cardiac muscle. *J. Physiol. (London)*. **157**:335.
 17. KRIEBEL, M. E. 1968. Electrical characteristics of tunicate heart cell membranes and nexuses. *J. Gen. Physiol.* **52**:46.
 18. KRIEBEL, M. E., M. V. L. BENNETT, S. G. WAXMAN, and G. D. PAPPAS. 1969. Oculomotor neurons in fish: electrotonic coupling and multiple sites of impulse initiation. *Science (Washington)*. **166**:520.
 19. KUFFLER, S. W., J. G. NICHOLLS, and R. K. ORKAND. 1966. Physiological properties of glial cells in the central nervous system of amphibia. *J. Neurophysiol.* **29**:768.
 20. KUFFLER, S. W., and D. D. POTTER. 1964. Glia in the leech central nervous system: physiological properties and neuron-glia relationship. *J. Neurophysiol.* **27**:290.
 21. LOEWENSTEIN, W. R., M. NAKAS, and S. J. SOCOLAR. 1967. Junctional membrane uncoupling. Permeability transformation at a cell membrane junction. *J. Gen. Physiol.* **50**:1865.
 22. PAPPAS, G. D., Y. ASADA, and M. V. L. BENNETT. 1967. Morphological and physiological changes in junctional sites of crayfish septate axons. *Anat. Rec.* **157**:297. (Abstr.)
 23. PAPPAS, G. D., Y. ASADA, and M. V. L. BENNETT. 1970. Morphological correlates of increased coupling resistance at an electrotonic synapse. *J. Cell Biol.* **49**:000.
 24. PAPPAS, G. D., and M. V. L. BENNETT. 1966. Specialized sites involved in electrical transmission between neurons. *Ann. N. Y. Acad. Sci.* **137**:495.
 25. PAYTON, B. W., M. V. L. BENNETT, and G. D. PAPPAS. 1969. Permeability and structure of junctional membranes at an electrotonic synapse. *Science (Washington)*. **166**:1641.
 26. PAYTON, B. W., and W. R. LOEWENSTEIN. 1968. Stability of electrical coupling in leech giant nerve cells. Divalent cations, propionate ions, tonicity and pH. *Biochim. Biophys. Acta.* **150**:156.
 27. PORTZEHL, H., P. C. CALDWELL, and J. C. RUEGG. 1964. The dependence of contraction and relaxation of muscle fibers from the crab *Maia squinado* on the internal concentrations of free calcium ions. *Biochim. Biophys. Acta.* **79**:581.
 28. POTTER, D. D., E. J. FURSHPAN, and E. S. LENNOX. 1966. Connections between cells of the developing squid as revealed by electrophysiological methods. *Proc. Nat. Acad. Sci. U.S.A.* **55**:328.
 29. REMLER, M., A. SELVERSTON, and D. KENNEDY. 1968. Lateral giant fibers of crayfish: location of somata by dye injection. *Science (Washington)*. **162**:281.
 30. STRICKHOLM, A., B. G. WALLIN, and P. SHRAGER. 1969. The pH dependency of relative ion permeabilities in the crayfish giant axon. *Biophys. J.* **9**:873.
 31. VAN HARREVELD, A. 1936. A physiological solution for fresh water crustaceans. *Proc. Soc. Exp. Biol. Med.* **34**:428.
 32. WATANABE, A., and H. GRUNDFEST. 1961. Impulse propagation at the septal and commissural junctions of crayfish lateral giant axons. *J. Gen. Physiol.* **45**:267.
 33. WOODBURY, J. M., and W. E. CRILL. 1961. On the problem of impulse conduction in the atrium. In *Nervous Inhibition*. E. Florey, editor. Pergamon Press Ltd., Oxford. **124**.